

F900 Smartphone Service Guide

Service guide files and updates are available on the ACER/CSD web; for more information, please refer to <http://csd.acer.com.tw>

PRINTED IN TAIWAN

Revision History

Please refer to the table below for the updates made on the F900 smartphone service guide.

Date	Chapter	Updates

Copyright

Copyright © 2009 by Acer Incorporated. All rights reserved. No part of this publication may be reproduced, transmitted, transcribed, stored in a retrieval system, or translated into any language or computer language, in any form or by any means, electronic, mechanical, magnetic, optical, chemical, manual or otherwise, without the prior written permission of Acer Incorporated.

Disclaimer

The information in this guide is subject to change without notice.

Acer Incorporated makes no representations or warranties, either expressed or implied, with respect to the contents hereof and specifically disclaims any warranties of merchantability or fitness for any particular purpose. Any Acer Incorporated software described in this manual is sold or licensed "as is". Should the programs prove defective following their purchase, the buyer (and not Acer Incorporated, its distributor, or its dealer) assumes the entire cost of all necessary servicing, repair, and any incidental or consequential damages resulting from any defect in the software.

Acer is a registered trademark of Acer Corporation.

Intel is a registered trademark of Intel Corporation.

Other brand and product names are trademarks and/or registered trademarks of their respective holders.

Conventions

The following conventions are used in this manual:

SCREEN MESSAGES	Denotes actual messages that appear on screen.
NOTE	Gives bits and pieces of additional information related to the current topic.
WARNING	Alerts you to any damage that might result from doing or not doing specific actions.
CAUTION	Gives precautionary measures to avoid possible hardware or software problems.
IMPORTANT	Reminds you to do specific actions relevant to the accomplishment of procedures.

Preface

Before using this information and the product it supports, please read the following general information.

1. This Service Guide provides you with all technical information relating to the BASIC CONFIGURATION decided for Acer's "global" product offering. To better fit local market requirements and enhance product competitiveness, your regional office MAY have decided to extend the functionality of a machine. These LOCALIZED FEATURES will NOT be covered in this generic service guide. In such cases, please contact your regional offices or the responsible personnel/channel to provide you with further technical details.
2. Please note WHEN ORDERING FRU PARTS, that you should check the most up-to-date information available on your regional web or channel. If, for whatever reason, a part number change is made, it will not be noted in the printed Service Guide. For ACER-AUTHORIZED SERVICE PROVIDERS, your Acer office may have a DIFFERENT part number code to those given in the FRU list of this printed Service Guide. You MUST use the list provided by your regional Acer office to order FRU parts for repair and service of customer machines.

System Specifications	1
Features	1
System Block Diagram	4
Your Acer Smartphone tour	5
Views	5
Hardware Specifications and Configurations	6
Software Upgrades	1
System Requirements	1
Mode Switching	1
Performing a Soft Reset	1
Switching to Download Mode	1
Performing a Clean Boot	1
Software Upgrade Procedure	1
Using a BIN File (For service center only)	1
Using the EUU (For distributor or service center)	2
Machine Disassembly and Replacement	1
Disassembly Requirements	1
Related Information	1
General Information	1
Pre-disassembly Instructions	1
Disassembly Process	1
External Module Disassembly Process	2
External Modules Disassembly Flowchart	2
Removing the Stylus	3
Removing the Mini-SD Card	4
Removing the Back Cover	6
Removing the Battery	7
Removing the SIM Card	8
Main Unit Disassembly Process	9
Main Unit Disassembly Flowchart	9
Removing the Upper Cover	11
Removing the LCD Module	16
Removing the Mainboard	18
Removing the Vibration Module	21
Removing the Receiver Module	22
Removing the SIM Board	23
Removing the Camera Shielding	25
Removing the Camera Module	26
Removing the Middle Cover	27
Replacing Internal Module Components	28
Replacing the Middle Cover	28
Replacing the Camera Module	31
Replacing the Camera Shielding	32
Replacing the SIM Board	32
Replacing the Receiver Module	34
Replacing the Vibration Module	34
Replacing the Mainboard	35
Replacing the LCD Module	37
Replacing the Upper Cover	38
Replacing Internal Module Components	40
Replacing the SIM Card	40
Replacing the Battery	41

Table of Contents

Replacing the Back Cover	41
Replacing the Mini-SD Card	42
Replacing the Stylus	43
Diagnostics and Troubleshooting	1
Using DebugSwitcher Function Testing	1
RUN IN and Discharge Tests	1
FM Receiver, Audio and GPS1 Tests	2
Camera Test	3
Function Testing 1	4
Function Testing 2	6
G Sensor and Light Sensor Tests	7
TV-out and GPS2 Test	8
Using the Windows Mobile Test System	9
Serial Number Definition	1
FRU (Field Replaceable Unit) List	1
F900 Smartphone Exploded Diagram	2
F900 Smartphone FRU List	4
Online Support Information	1
Index	1

System Specifications

Features

Below is a brief summary of the smartphone's many features:

Operating System

- Windows Mobile® 6.1 Professional for Pocket PC Phone Edition

Processor

- Samsung SC3 6410, 533 MHz with one DRAM

Memory

- 256 MB Flash ROM, 128 MB SDRAM

Display

- 3.8", 800 x 480 (VGA), 65,536 colors, TFT-LCD touch panel/window

Dimensions and Weight

- 117.5 (L) x 63.5 (W) x 12.9 (H) mm
- 155 g (including battery and stylus)

Communications

- HSDPA / UMTS (2100/1900/850 MHz)
- Quad-Bands GSM: 850/900/1800/1900 MHz
- EDGE class 10/GPRS class 10

Wireless LAN

- 802.11b/g

Modem

- EMP U365 (POP)

GPS

- Embedded SiRF Star III chipset **TMC function supported (subject to region availability)**

Bluetooth

- Bluetooth 2.0 class 2+EDR

Camera

- Built-in 3 mega pixels auto-focus CMOS camera with flashlight, up to 2048 x 1536 resolution
- VGA resolution fixed-focus CMOS camera for video telephony usage

Light sensor

- Sensing the brightness of environment to adjust panel luminance

TV-out

- Composite TV out

Radio

- FM 76 ~ 108MHz, support Channel Search

Expansion Options

- MicroSD card slot

Interface/Audio

- Built-in microphone and speaker, hands-free mode supported

Interface/Data

- Mini USB Sync

Ergonomic Design

- Touch panel for stylus or fingertip
- Buttons:
 - Power button
 - Camera shutter key
 - Reset button
 - Record button
 - Volume control key
 - Send/End key
 - Quick Application key x 2 (GPS hotkey /TBD)
- Gravity Sensor for user-friendly operation

Power

- DC Adaptor, 5V, 1A

Battery

- 1530 mAh, rechargeable Lithium Polymer
 - Talk time: 3G: 4 hours, 2G: 6 hours (backlight off)
 - Standby: 245 hours (WCDMA), 275 hours (GSM)

-
- Pocket PC usage: 15 hours
 - GPS usage: 5 hours

Software (pre-loaded*)

- Windows Mobile® 6.1 Professional
- Microsoft® Office Outlook Mobile (Calendar, Contacts, Tasks and Inbox)
- Microsoft® Office Word Mobile / Microsoft® Office Excel Mobile / Microsoft® Office PowerPoint Mobile
- MSN® Messenger / Microsoft® Transcriber / Windows Media® Player 10
- Picture / Notes / Internet Explorer Mobile / ActiveSync / Calculator / Game (Solitaire, Bubble Breaker)
- Microsoft Reader* (* depends on region)

Acer Exclusive Applications

- User interface:
 - Acer Shell v2.0
- Phone Tools:
 - Phone Application*, Phone Setting, SIM Toolkit, Speed Dial, Call Filter, Wireless Modem, Wireless Manager, Dialer Skin, Add Ringtone, CSD Type, Voice Commander*, Connection Wizard, SMS Sender, MMS Composer*, SIM Manager, Video Telephony, (*Subject to change by region)
- Multimedia Tools:
 - Image Maker, Multimedia Manager, Camera (Camcorder, Image Wizard), FM Tuner* (*Subject to change by region)
- Utilities:
 - Quick Link, Battery Meter, Zoom SMS, Bluetooth Manager, M-Desk, Scenario, Backup Utility, Name card Manager
- GPS Tools:
 - Satellite Data Update, Location SMS

System Block Diagram

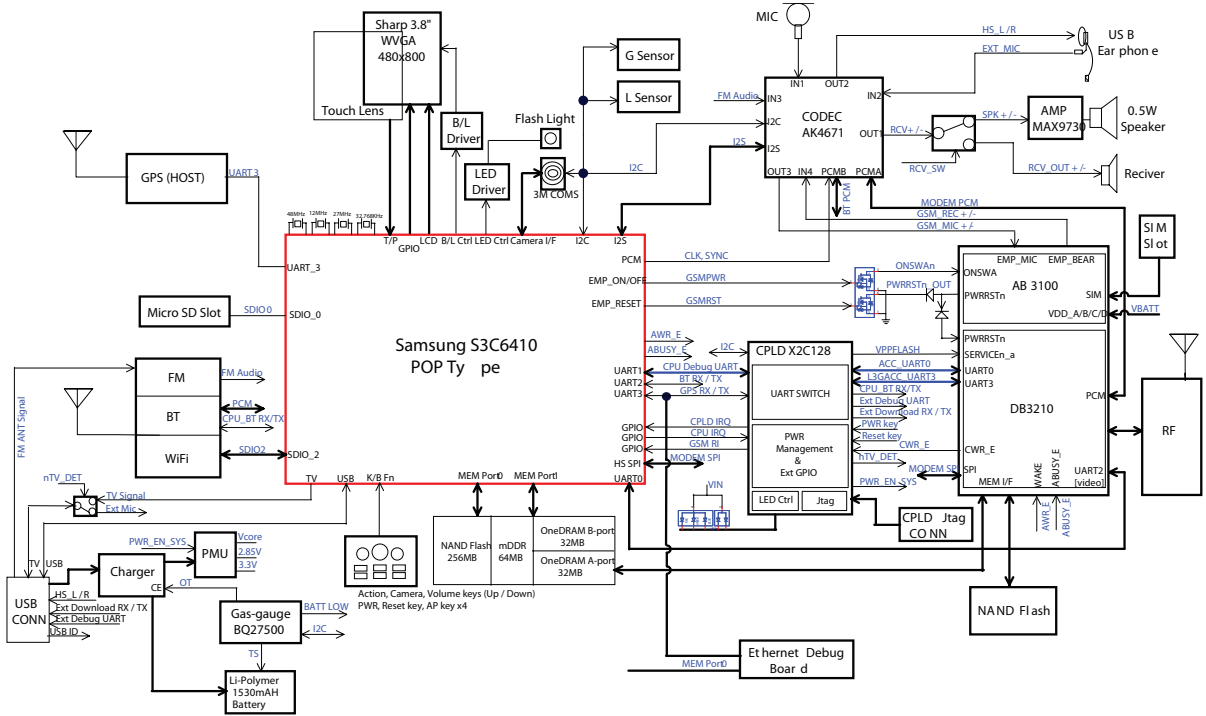

Your Acer Smartphone tour

After examining your smartphone features, let us show you around your new smartphone.

Views

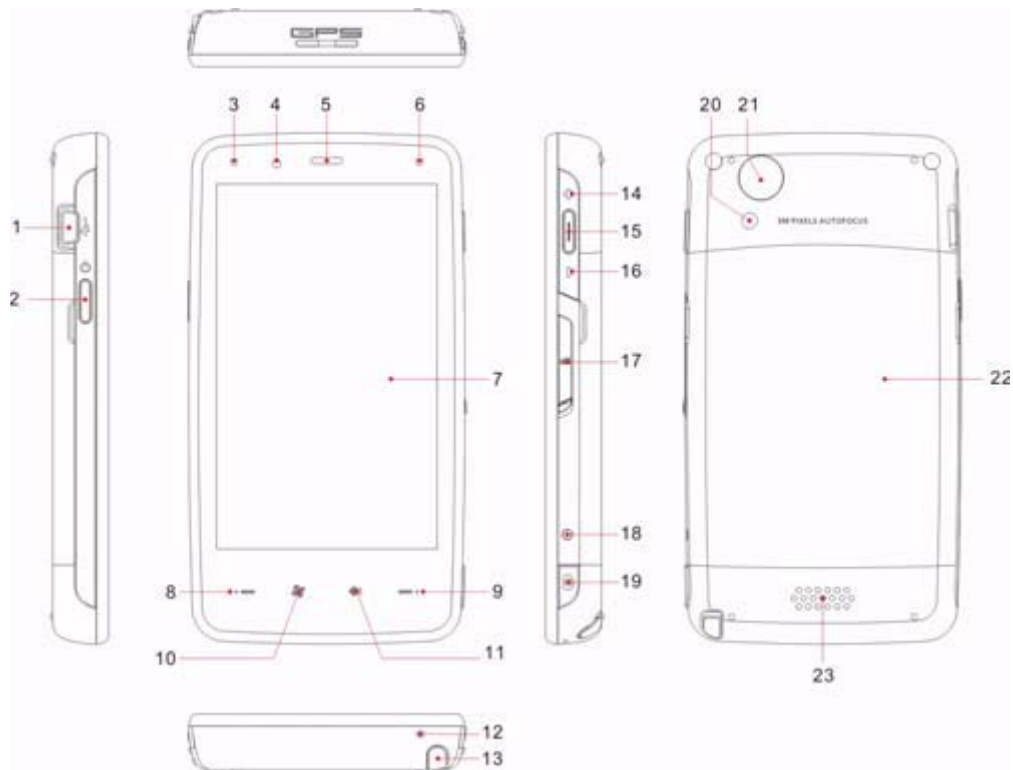

No.	Item	Description
1	Mini USB connector	Connect to a USB cable/headphones/ charger.
2	Power button	Press to turn the screen on/off or enter sleep mode; press and hold to turn the smartphone off.
3	Bluetooth/WLAN/GPS indicator	Indicates Bluetooth, WLAN and GPS status.
4	Light sensor	Senses ambient light to adjust screen brightness for comfortable viewing.
5	Phone speaker	Emits audio from your smartphone; suit-able for holding to your ear.
6	Charge indicator	Indicates battery charge status.
7	Touchscreen	800 x 480 pixel screen to display data, phone content and enter information.
8	Talk/send button	Activate phone/dial/view recently dialed numbers/answer a call.
9	End button	Press to end a call/disconnect GPRS; press and hold to turn the phone function on/off.
10	Windows button	Press to open the Start menu.
11	OK/close button	Press to activate the OK/X function (if avail-able in the top right-hand corner of the screen).
12	Microphone	Internal microphone.
13	Stylus	Use to enter information or select items on the touch screen.
14	Volume up	Press to increase the phone volume.

No.	Item	Description
15	Action key	Press to activate the selected menu item.
16	Volume down	Press to reduce phone volume.
17	Micro SD card slot	Expand your device's memory capacity.
18	Reset pinhole	Insert the stylus into this hole to reset the device.
19	Camera button	Activate the camera or take a picture. Press down halfway to auto-focus.
20	Flash	Used to illuminate an object when taking photos in low-light conditions.
21	Camera	A 3.2-megapixel camera for taking high-resolution images.
22	Battery cover	Covers the battery/SIM card bay.
23	Speaker	Emits audio from your smartphone; suit-able for handsfree use.

Hardware Specifications and Configurations

Processor

Item	Specification
CPU type	Samsung SC3 6410 533 MHz
CPU package	424-pins FBGA
Core Logic	ARM1176JZF-S
Features	<ul style="list-style-type: none"> 16/16KB I/D Cache, 16/16KB I/D TCM One 8-bit ITU 601/656 Camera Interface up to 4M pixel for scaled and 16M pixel for un-scaled resolution Multi Format CODEC provides encoding and decoding of MPEG-4/H.263/H.264 >30fps@SD/D1 and decoding of VC1 video >30fps@SD/D1 9M triangles/sec 3D graphics accelerator with OpenGL ES 1.1 / 2.0, D3DM API support 2D Graphics Accelerator with BitBlit and Rotation 3-ch I2S: Dolby 5.1 channel support and combined PCM and AC97 I/F 1/2/4/8 bpp Palletized or 8/16/24bpp Non-Palletized Color-TFT support up to 1024x1024 2-Channel I2C interface support Dedicated IrDA 1.1 port Configurable GPIOs On-chip USB 2.0 OTG controller and transceiver supporting high speed (480Mbps, on-chip transceiver) On-chip USB 1.1 Host controller and transceiver supporting full speed (12Mbps, on-chip transceiver) 3-Channel HS-MMC/MMC/SDHC/SDIO card support CF+ and CompactFlashSpec 3.0 compatible (except MDMA operation) Real time clock, 3 PLL's, timer with PWM and watch dog timer 32 channel DMA controller Support 8X8 key matrix 8-ch 12-bit ADC (Touch screen interface)
Supply Voltage	1.1V

System Memory

Item	Specification
Memory controller	On Board
Memory size	256 MB Flash ROM, 128 MB SDRAM

TFT 3.8"

Item	Specification
Vendor/model name	
Screen Diagonal (mm)	
Active Area (mm)	
Display resolution (pixels)	800 x 480 (VGA)
Pixel Pitch (mm)	
Typical White Luminance (cd/m ²) also called Brightness	
Supported Colors	65,536
Contrast Ratio	
Response Time (Optical Rise Time/Fall Time) msec	
Typical Power Consumption (watt)	
Weight	
Physical Size (mm)	
Electrical Interface	
Viewing Angle (degree) Horizontal (Right) CR = 10 (Left) Vertical (Upper) CR = 10 (Lower)	

Camera

Item	Specification
Model	1/4" QXGA CMOS
Type	<ul style="list-style-type: none"> Built-in 3.2 mega pixels Auto-Focus CMOS camera, up to 2048 x 1536 resolution LED flash 0.3 mega pixels Fixed-Focus CMOS camera for Video Telephony usage

GPS

Item	Specification
Type	<ul style="list-style-type: none"> SiRF Star III
Protocol	<ul style="list-style-type: none"> NMEA, SiRF binary
TTFB (Cold start)	<ul style="list-style-type: none"> TBD
Sensitivity	<ul style="list-style-type: none"> -159dbm

WiFi

Item	Specification
Type	802.11b/g (WPA, WPA2)
Features	<ul style="list-style-type: none"> SPI interface

Bluetooth

Item	Specification
Type	Bluetooth 2.0, class 2 + EDR
Interface	UART
Profiles	Generic, Serial, FTP, A2DP, Headset, Hands Free

FM Radio

Item	Specification
Frequency	76 ~ 108MHz
Channel Search	Yes
Audio Mute	Yes
RDS Supported	Yes
Antenna	External (by Headset)

Battery

Item	Specification
Vendor & model name	Welldone US454261 A8T
Battery Type	Lithium-ion Polymer
Rating	3.7 VDC
Maximum Charging Voltage	4.2 VDC
Pack capacity	1530 mAh
Battery Life	
Talk time	3G: 4 hours dependent on usage / 2G: 6 hours dependent on usage
Standby	245 hours (WCDMA), 275 hours (GSM)
Pocket PC usage	15 hours
GPS usage	5 hours

Software Upgrades

System Requirements

- Microsoft® Windows XP or above
- Latest version of EEU (End-user Upgrade Utility / EEU_xxx.exe) or Bin files for x960
- Latest version of ActiveSync v4.5 or above
- Tool: USB Cable

NOTE: E-ten releases both EEU and Bin file for an authorized Service Center. Distributors and local service agent only receive EEU software.

Mode Switching

Performing a Soft Reset

1. Press and hold the POWER button.
2. Press RESET and release both (power & reset) buttons at the same time.

Switching to Download Mode

1. Perform a soft reset.
2. Immediately press and hold the **ACTION**, **POWER** and **RESET** buttons simultaneously.
3. Release the three buttons when the USBDL screen displays on the screen.

Performing a Clean Boot

1. Perform a soft-reset, device reboot.
2. Press volume up and volume down at the same time until the clean boot message appears.

Software Upgrade Procedure

Using a BIN File (For service center only)

1. Save the bin file to a Micro SD card.
2. Insert the Micro SD card into the device.
3. Activate **DOWNLOAD** mode:
 - a. Perform a soft reset.
 - b. Immediately press and hold the **ACTION**, **POWER** and **RESET** button simultaneously.
 - c. Release the three buttons when the USBDL screen displays on the screen.
4. The device begins the upgrade from the BIN file on the Micro SD card automatically.

Using the EEU (For distributor or service center)

1. Execute ActiveSync.
2. Connect with PC.
3. Execute EEU_xxx.exe

The Welcome screen displays.

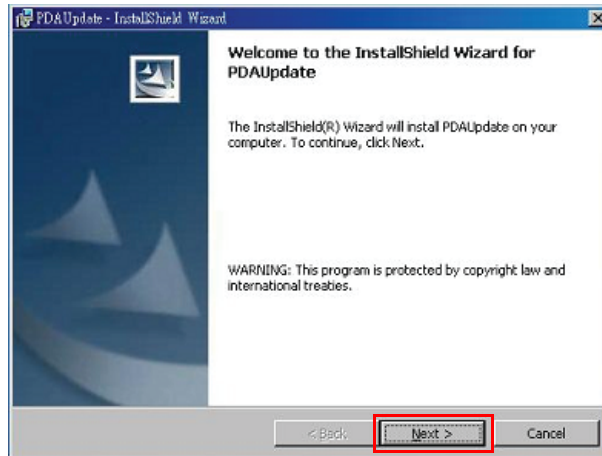

4. Click **Next**.

When EEU is installed, the **Completed** screen displays.

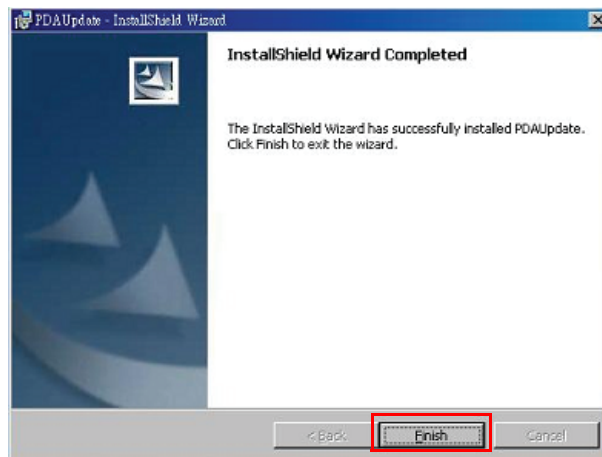

5. Click **Finish**.

The **End User Update** utility starts and the following screen displays.

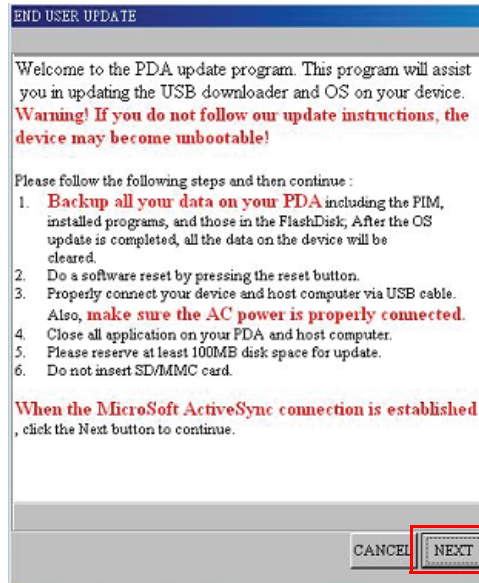

6. Follow the on screen instructions. When the ActiveSync connection is established, click **Next**.

The following screen displays.

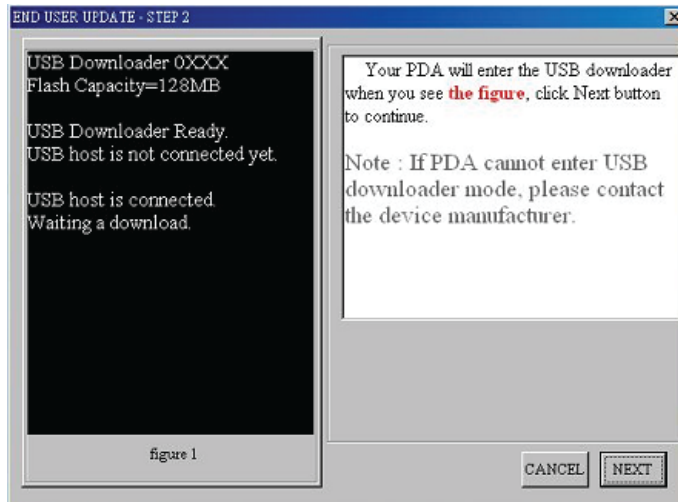

7. When the device enters **Download** mode (as described on screen) click **Next**.
NOTE: If the device does not enter **Download** mode, contact the service center.

The following screen displays.

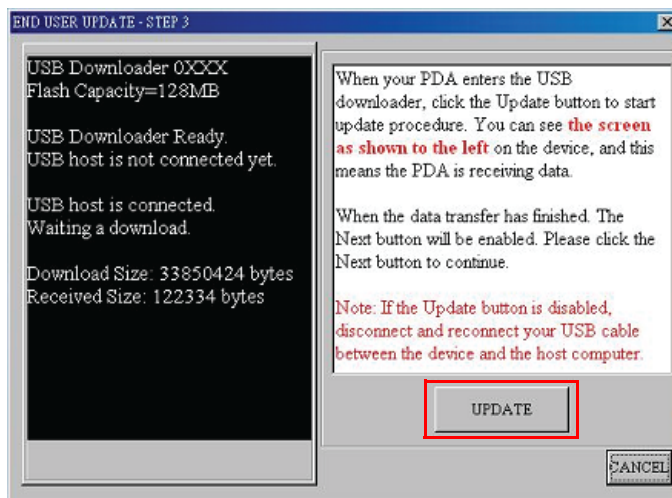

8. Click **Update** to begin receiving data.
NOTE: If the Update button is disabled, disconnect and reconnect the USB cable between the device and host computer.
9. Once the data is downloaded, the **Update** button is replaced with a **Next** button.
10. Click **Next** to continue.

A warning screen displays.

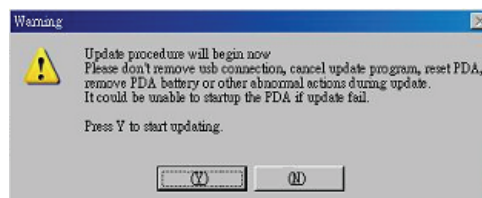

11. Click **(Y)** to begin the upgrade.

A progress screen displays.

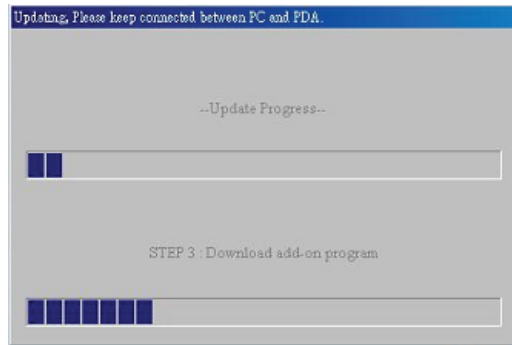

The update is complete when the following screen displays.

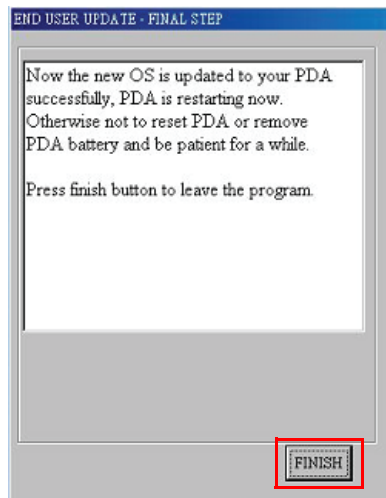

12. Click **Finish** to complete the process.

Machine Disassembly and Replacement

This chapter contains step-by-step procedures on how to disassemble and reassemble the smartphone for maintenance and troubleshooting.

IMPORTANT:The use of metal tools during disassembly may damage the casing. Use plastic tools where possible.

IMPORTANT:Cover the work area with a clean, dry, lint-free cloth before placing the smartphone face down.

Disassembly Requirements

To disassemble the smartphone, you need the following tools:

- Wrist grounding strap and conductive mat to prevent electrostatic discharge
- A clean, dry, lint free cloth to prevent damage to the LCD during disassembly
- Plastic pry less than or equal to 0.96 mm thickness
- Tweezers (plastic and metal)

NOTE: The screws for the different components vary in size. During the disassembly process, group the screws with the corresponding components to avoid mismatch when putting back the components.

Related Information

The product previews seen in the disassembly procedures may not represent the final product color or configuration.

General Information

Pre-disassembly Instructions

IMPORTANT:Before proceeding with the disassembly procedure, make sure that you do the following:

1. Turn off the power to the system.
2. Unplug the USB adapter and all other cables from the system.
3. Cover the work area with a clean, dry, lint-free cloth to protect the LCD panel.
4. Place the system on a flat, stable surface.

Disassembly Process

The disassembly process is divided into the following sections:

- External components disassembly
- Main unit disassembly

The flowcharts provided in the succeeding disassembly sections illustrate the entire disassembly sequence. Observe the order of the sequence to avoid damage to any of the hardware components.

Main Screw List

Screw	Quantity	Part Number

External Module Disassembly Process

External Modules Disassembly Flowchart

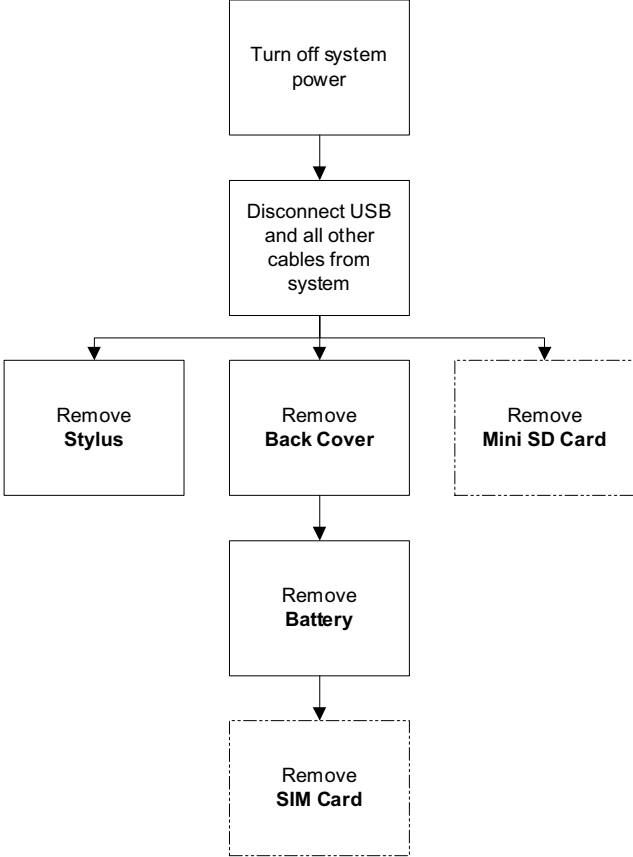

NOTE: Items enclosed with broken lines (— - - —) are optional and may not be present.

Removing the Stylus

1. Grasp the Stylus as shown and pull to remove it from the smartphone.



2. Continue to pull the Stylus until it is completely removed from the smartphone.



Removing the Mini-SD Card

NOTE: The Mini SD Card is an optional item and may not be present.

1. Insert a finger nail (or plastic pry) into the casing and open the Mini SD door as shown.



2. Rotate the Mini SD door away from the card slot as shown.



3. Press the Mini SD card into the slot and release. The card ejects automatically.



-
4. Remove the card from the slot and replace the Mini SD door.



Removing the Back Cover

IMPORTANT: Cover the work area with a clean, dry, lint-free cloth before placing the smartphone face down.

1. Press the two cover securing latches inward as shown.



2. Rotate the Back Cover away from the smartphone to remove it.



Removing the Battery

IMPORTANT: The Battery is locked in place; do not force the Battery out of the battery bay before open in the locking mechanism.

1. See “Removing the Back Cover” on page 6.
2. Slide the Battery lock in the direction of the arrow to release the Battery.



3. Insert a thumb into the Battery cutout as shown and lift the Battery out of the battery bay.



Removing the SIM Card

NOTE: The SIM Card is an optional item and may not be present.

1. See “Removing the Battery” on page 7.
2. Slide the SIM Card out of the SIM slot as shown.



3. Lift the SIM Card clear of the smartphone as shown.



Main Unit Disassembly Process

Main Unit Disassembly Flowchart

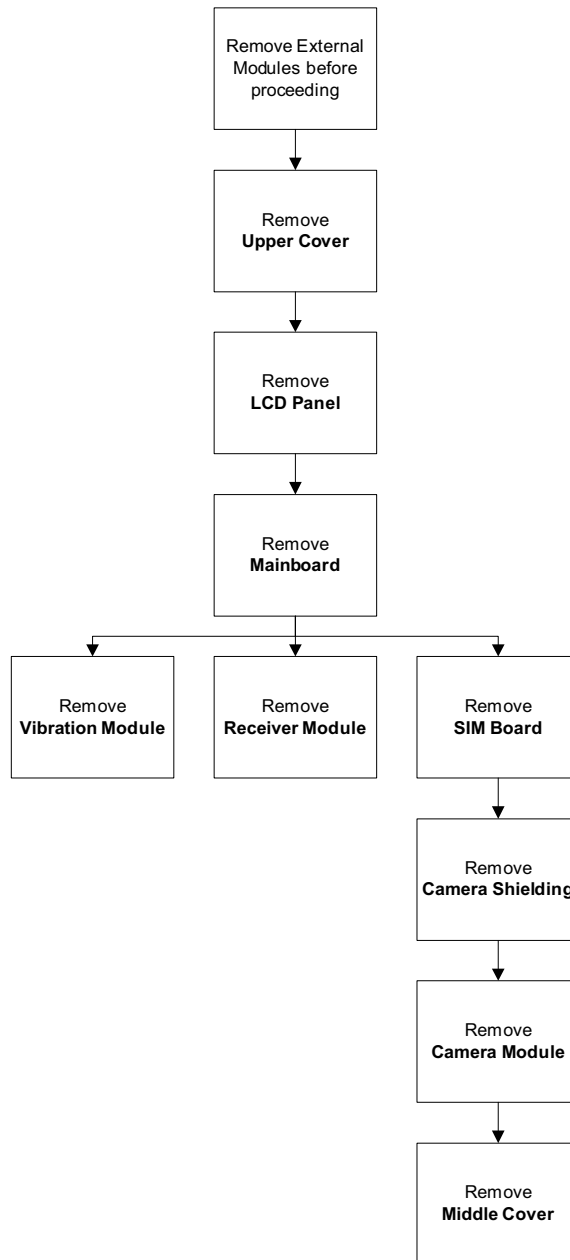

Screw List

Step	Screw	Quantity	Part No.
Upper Cover	M1.6*5	2	
	M1.6*1.5	2	
Mainboard	M1.6*2	2	
	M1.6*3.5	2	
	M1.6*5	2	

Step	Screw	Quantity	Part No.
SIM Board	M1.6*1.5	2	

Removing the Upper Cover

1. See "Removing the Battery" on page 7.
2. Remove the two rubber screw caps from the Lower Cover using tweezers.

IMPORTANT:Thin tine metal tweezers can be used to remove the screw covers. Take care not to scratch the Lower Cover during removal.



3. Remove the two screws located under the rubber screw caps.



Step	Screw	Quantity	Screw Type
Upper Cover	M1.6*5	2	

- Remove the two screws located on the sides of the Lower Cover.



Step	Screw	Quantity	Screw Type
Upper Cover	M1.6*1.5	2	

IMPORTANT: Do not force the covers apart to avoid damaging the plastic securing clips.

IMPORTANT: Use a plastic pry less than or equal to 0.96 mm thickness. Metal tools may damage the covers.

- Starting at the top-right edge of the smartphone, pry apart the covers.



- Work along the top edge of the cover as shown, gently prying the covers apart.



7. Work down the right side of the cover as shown, prying the covers apart.



8. Repeat the process down the left side, gradually prying apart the covers.



9. Apply lateral pressure as indicated by the arrow (1) and pry apart the bottom right edge of the Upper Cover (2).



10. Work along the bottom edge prying the covers apart as shown.



IMPORTANT: Do not remove the Upper Cover completely; the TouchPad FFC is still connected at this stage.

11. Lift the Upper Cover away from the Lower Cover and turn it over to expose the TouchPad FFC.

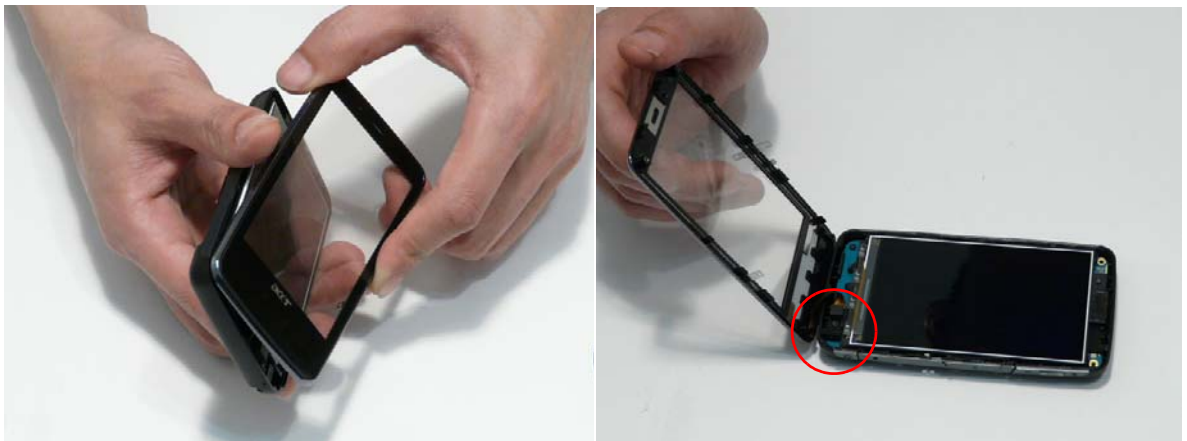

12. Using plastic tweezers, lift the FFC connector to disconnect the Upper Cover from the Mainboard.



13. Remove the Upper Cover from the Lower Cover and place it on a clean, dry, lint-free cloth.

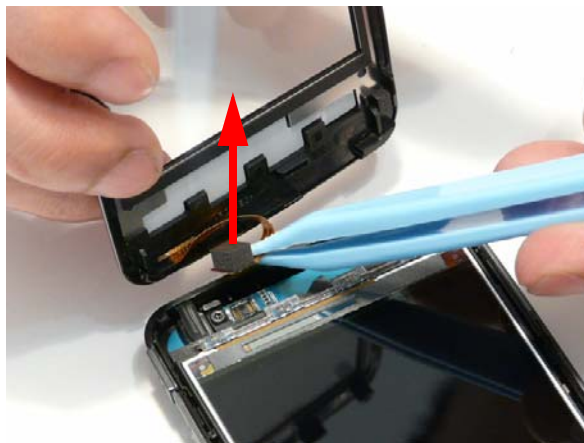

14. The Lower and Upper Covers appear as shown below when separated.

IMPORTANT: Ensure that no dust, dirt, or finger prints come in to contact with the exposed LCD Panel or Front Cover; Foreign particles and grease will affect LCD output performance.



Removing the LCD Module

IMPORTANT: Ensure that no dust, dirt, or finger prints come in to contact with the exposed LCD Panel or Front Cover; Foreign particles and grease will affect LCD output performance.

1. See “Removing the Upper Cover” on page 11.

IMPORTANT: The LCD Panel is not secured to the Lower Cover. Support the panel before turning the Lower Cover over.

2. Turn the smartphone over to release the LCD Panel from the Lower Cover.

IMPORTANT: Do not remove the LCD Panel completely; the panel FFC is still connected at this stage.



3. Place the Lower Cover on a flat surface and disconnect the LCD FFC as shown.



4. Lift the FFC cable as shown and peel back the gasket to remove the LCD Panel.

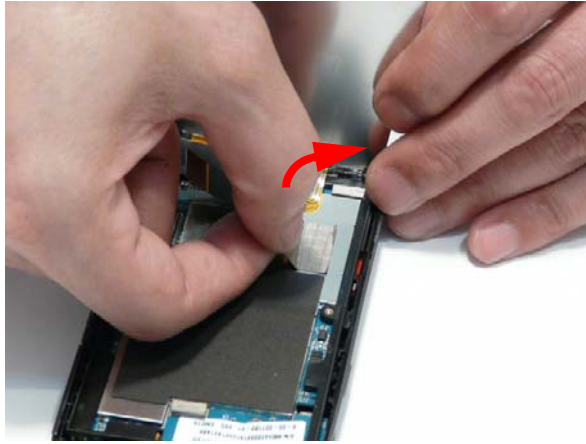

Removing the Mainboard

1. See "Removing the LCD Module" on page 16.
2. Turn the smartphone over. Remove the two screws securing the Mainboard to the Lower Cover.



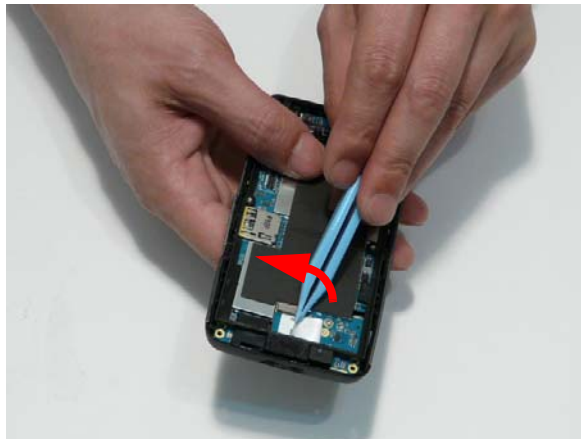

Step	Screw	Quantity	Screw Type
Mainboard	M1.6*2	2	

3. Turn the smartphone over. Peel back the barcode to expose the securing screw.

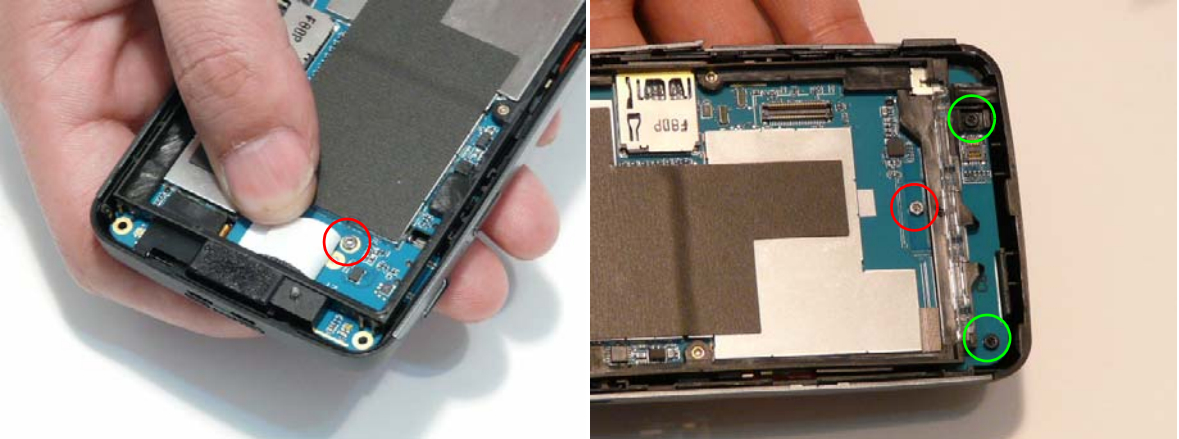

- Remove the four screws securing the Mainboard to the Lower Cover.



Step	Screw	Quantity	Screw Type
Mainboard (red callout)	M1.6*3.5	2	
Mainboard (green callout)	M1.6*5	2	

- Remove the rubber protector from the Microphone as shown.

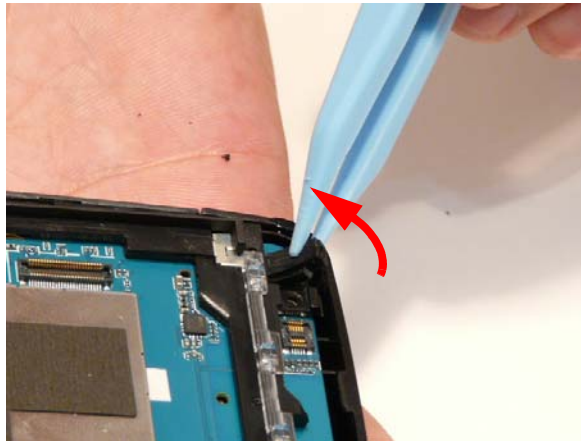

- Remove the two spacer pads from the Mainboard as shown below

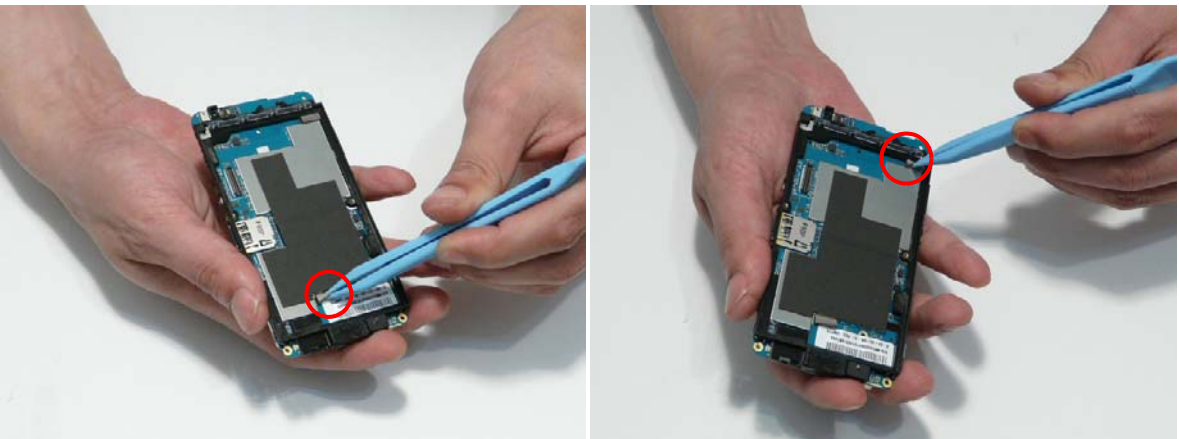

-
7. Grasp the Lower Cover as shown (1). Lift and rotate the Mainboard out of the Lower Cover (2) to clear the I/O ports (green callout).

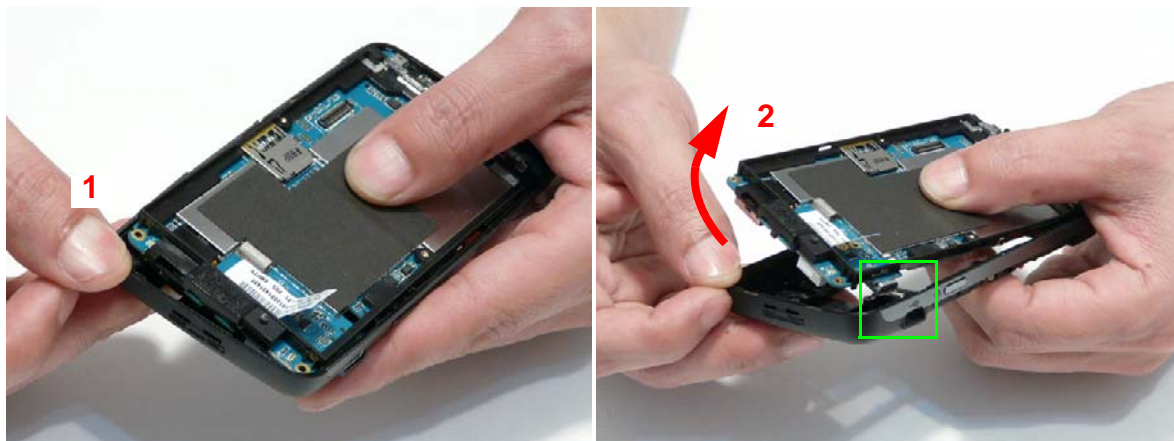

Removing the Vibration Module

1. See “Removing the Mainboard” on page 18.
2. Using the tweezers, grasp the Vibration Module and lift it clear of the Lower Cover.



3. Ensure that the rubber insulation lifts free along with the Vibration Module.

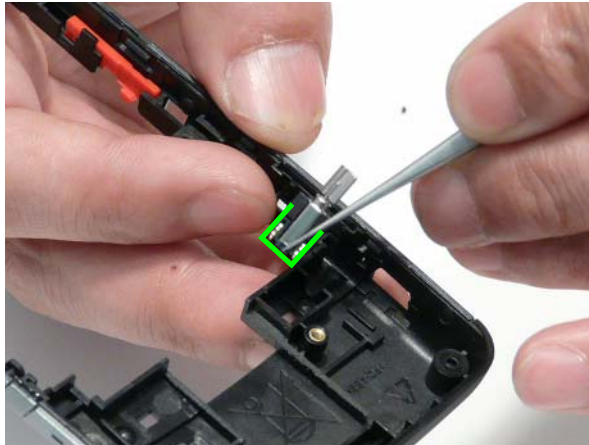

Removing the Receiver Module

1. See “Removing the Mainboard” on page 18.
2. Locate the removal tab as shown.



3. Press the removal tab toward the outside of the Lower Cover. The Receiver Module top edge lifts out of the Lower Cover.

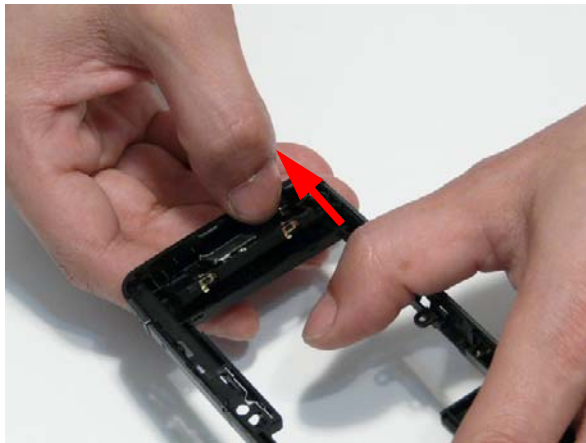

4. Lift the Receiver clear of the Lower Cover.



Removing the SIM Board

1. See "Removing the Mainboard" on page 18.
2. Remove the two screws securing the SIM Board to the Mainboard.



Step	Screw	Quantity	Screw Type
SIM Board	M1.6*1.5	2	

IMPORTANT: Do not remove the SIM Board completely; the SIM FFC is still connected at this stage.

3. Lift the SIM Board away from the Mainboard as shown.

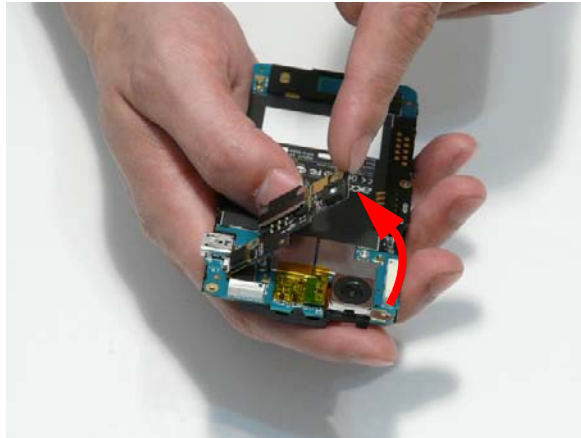

4. Disconnect the SIM Board FFC from the Mainboard.

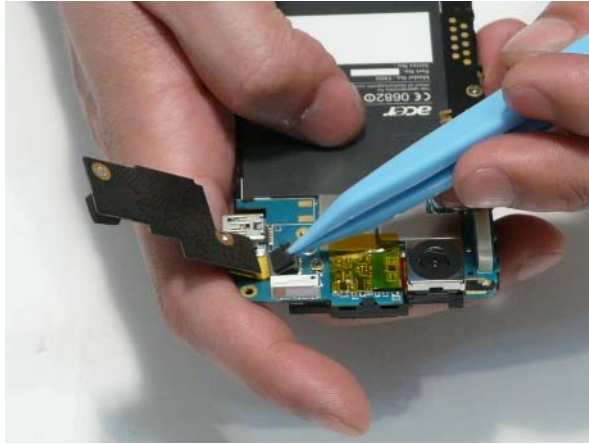

5. Disconnect the FFC from the SIM Board.

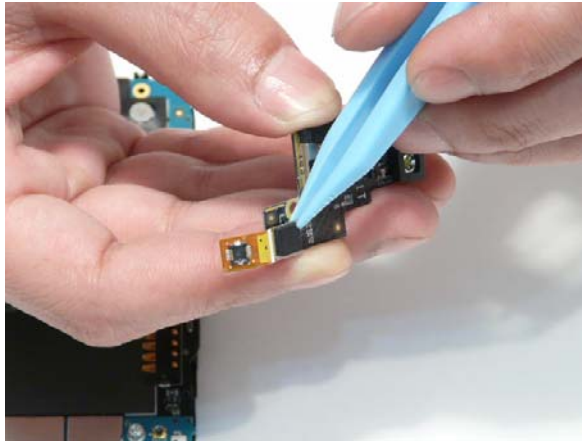

Removing the Camera Shielding

1. See “Removing the SIM Board” on page 23.
2. Insert thin tweezers either side of the Shielding securing clip and gently pry the Shielding away from the Mainboard.

NOTE: When removing the Shielding, it may be necessary to loosen the securing clip on the opposite side of the module to release it from the Mainboard

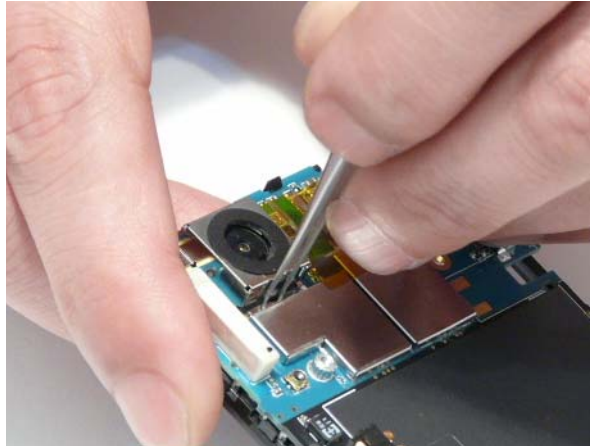

3. Lift the Shielding clear of the Mainboard to expose the Camera Module.

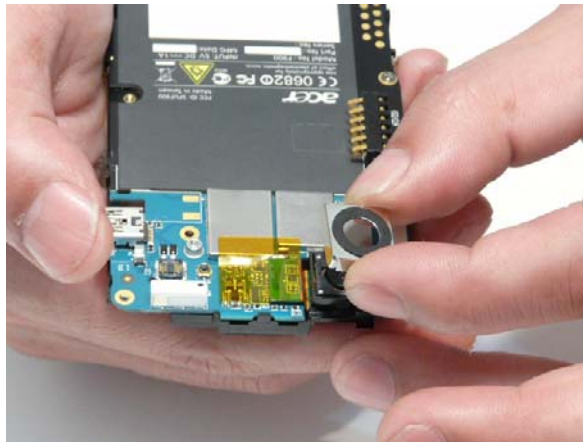

Removing the Camera Module

1. See “Removing the Camera Shielding” on page 25.

IMPORTANT: Do not disconnect the Camera Module by lifting the lens directly. Use tweezers to disconnect the interface to avoid damaging the camera FFC.

2. Remove the adhesive tape securing the Camera FFC in place.



3. Using the tweezers, pry up the FFC connector to disconnect the FFC.

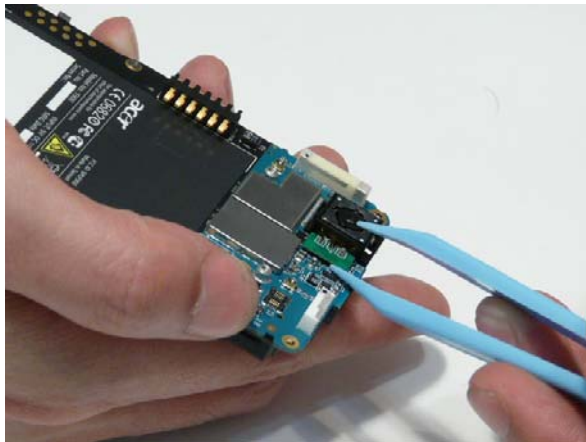

4. Lift the Camera Module and push the FFC cable through the Middle Cover to remove the Camera Module.

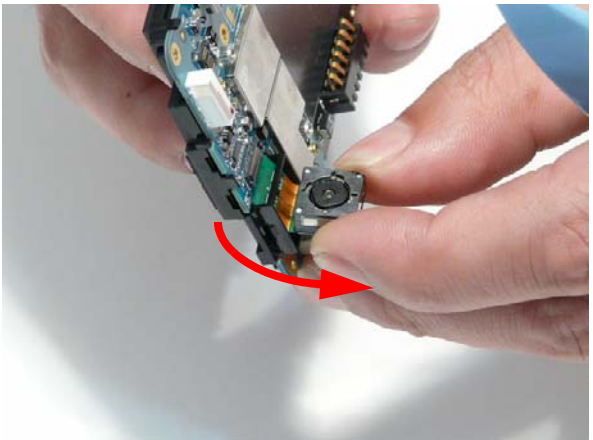
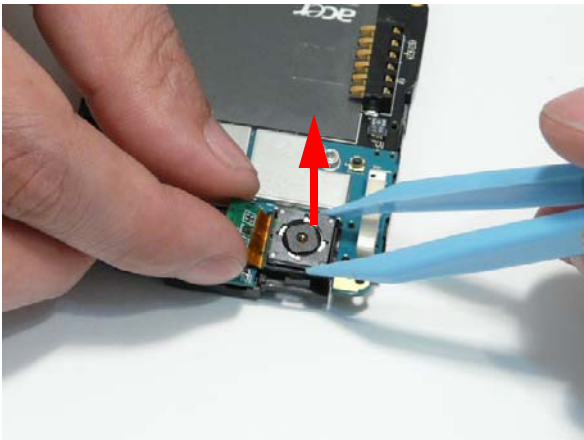

Removing the Middle Cover

1. See “Removing the Camera Module” on page 26.
2. Locate the four clips securing the Middle Cover to the Mainboard.

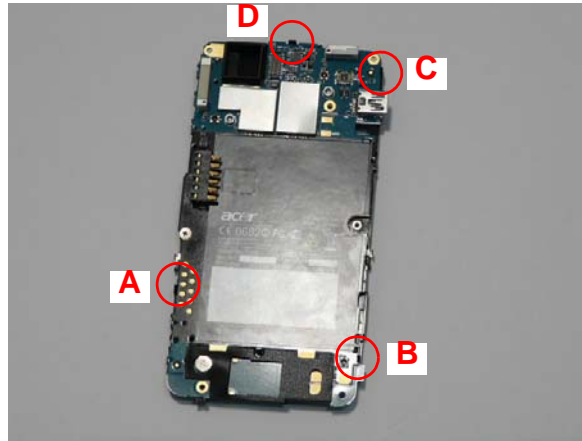

3. Release clip A by pushing it away from the Mainboard as shown.

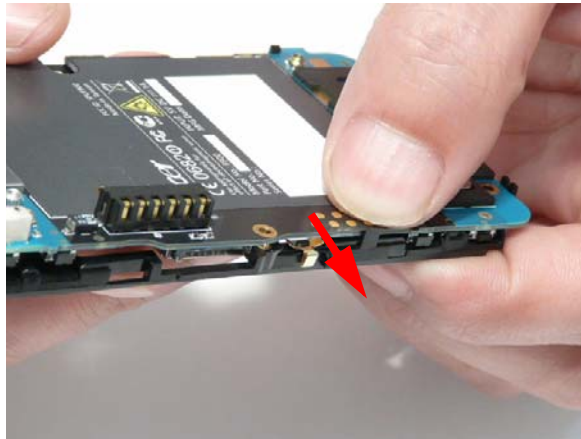

4. Release clip B by pushing it away from the Mainboard as shown.

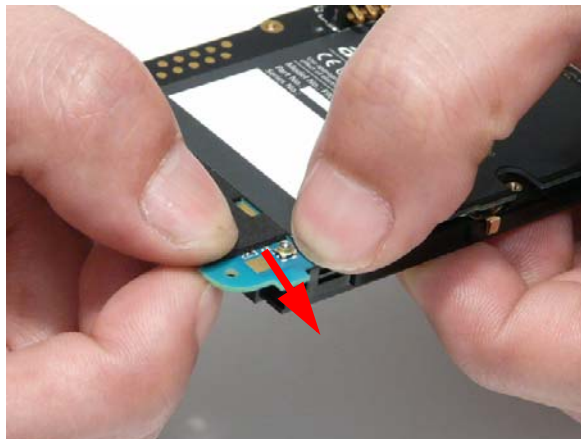

5. Release clip C by pushing it away from the Mainboard as shown.



6. Lift the Mainboard away from the Middle Cover as shown, and slide the Mainboard clear of the clip D.

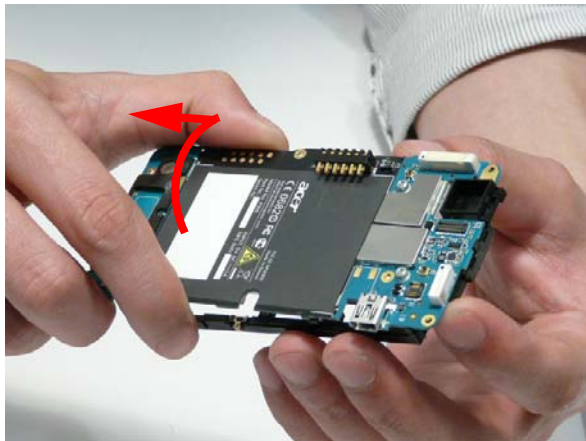

Replacing Internal Module Components

Replacing the Middle Cover

1. Four clips secure the Middle Cover to the Main Board as shown below. Insert the main board into the Middle cover so the clips (denoted by circles) and the pins (denoted by arrows) are aligned.

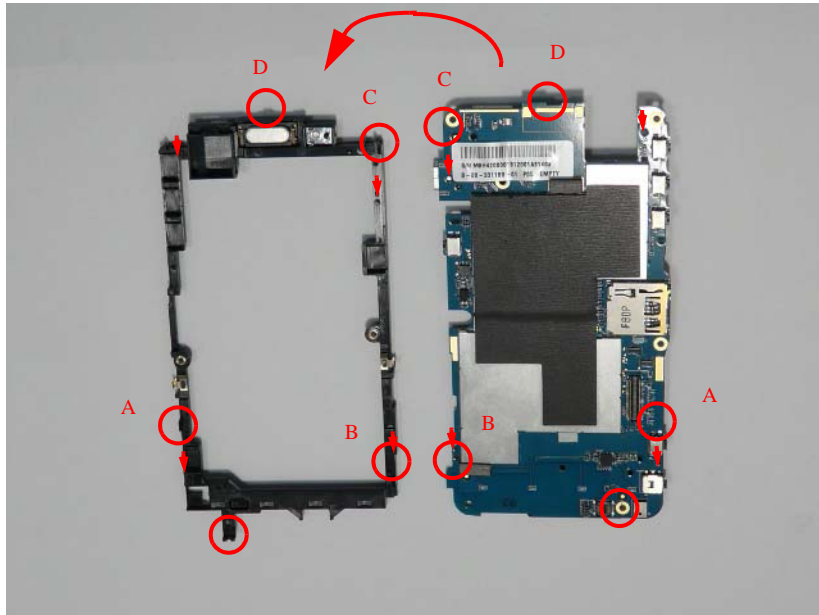

1. Insert clip A and the nearby pin by pushing it into from the Mainboard as shown.

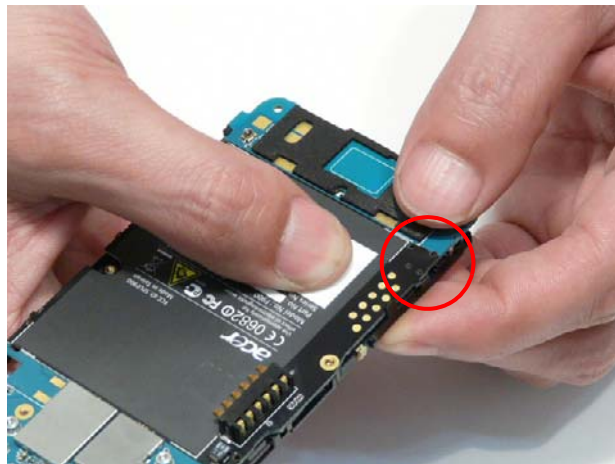

2. Insert clip B and the nearby pin by pushing it into the Mainboard as shown.



3. Insert clip C and the nearby pin by pushing it into the Mainboard as shown. Take care the pin is properly mounted as it is hidden under the USB port after connection.

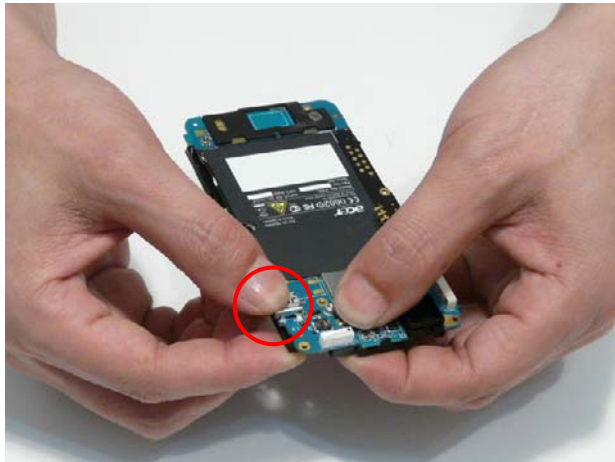

4. Insert clip D and the nearby pin by pushing it into the Mainboard as shown.

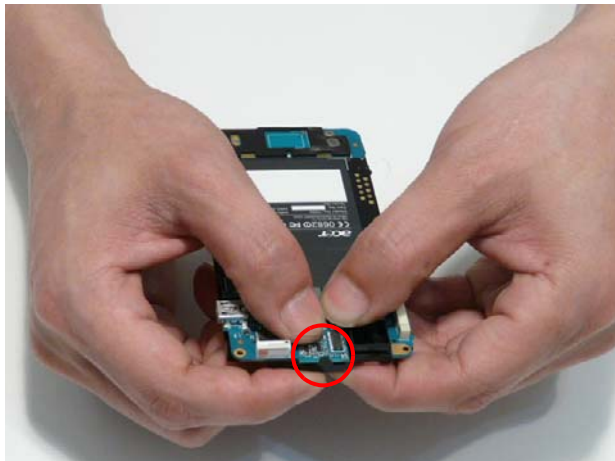

Replacing the Camera Module

1. Push the FFC cable through the slot in the side of the Middle Cover camera well.

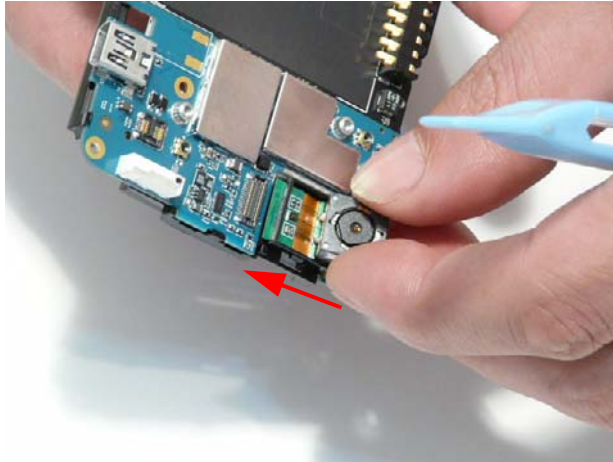

2. Slide the camera into the camera well in the middle cover.

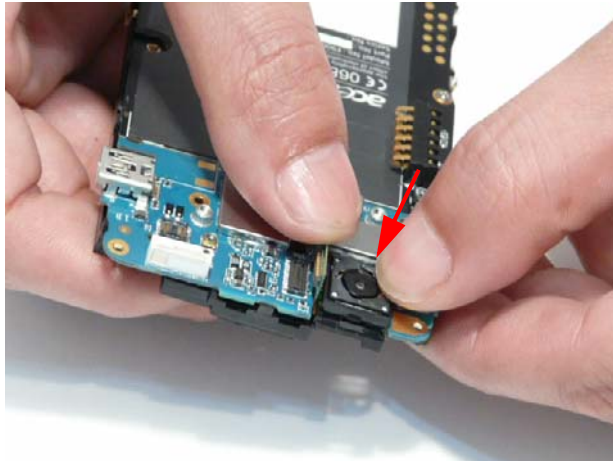

3. Connect the FFC as shown.

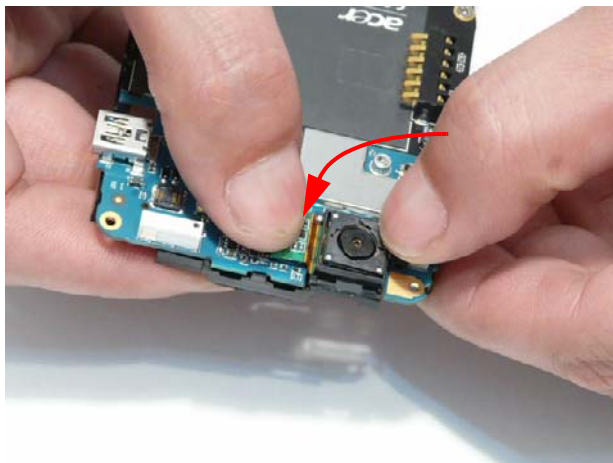

4. Reapply the adhesive tape to secure the Camera FFC in place.

Replacing the Camera Shielding

1. Slide the camera shield over the camera well on the middle board.

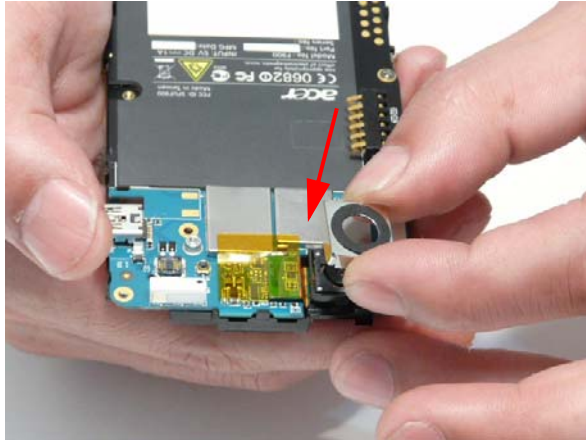

2. Push the tabs down to be sure that the securing clips on the camera well are inserted into the shielding.

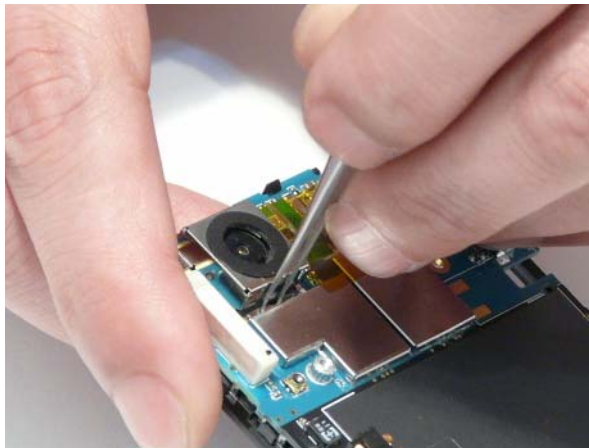

Replacing the SIM Board

1. Connect the FFC to the SIM Board.

IMPORTANT: Be sure that the end of the FFC connector with the white stripe is connected to the SIM Board.

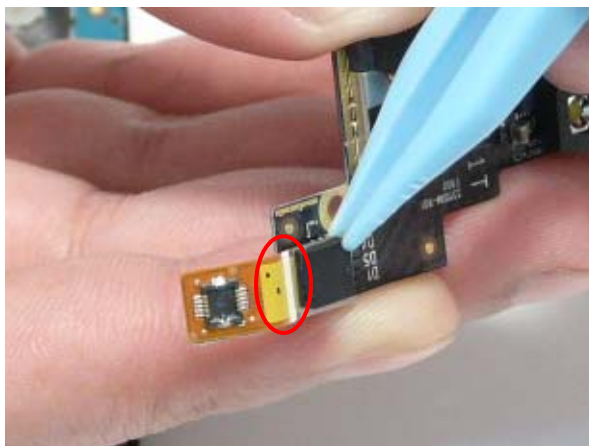

2. Connect the SIM Board FFC from the Mainboard.

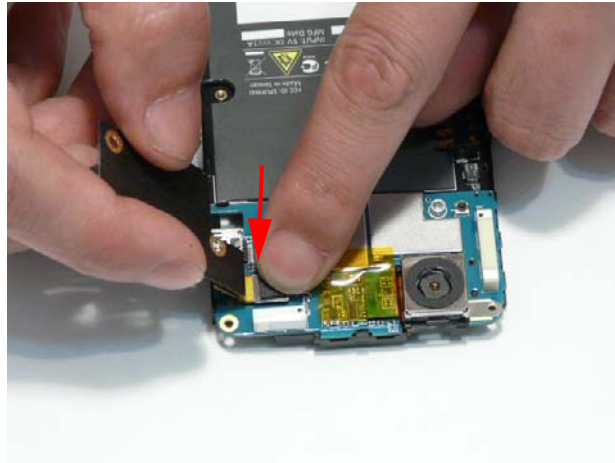

3. Lift the SIM Board away from the Mainboard as shown.

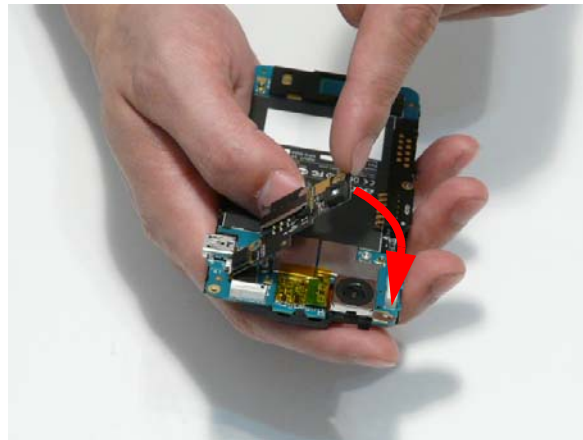

4. Insert the two screws to secure the SIM Board to the Mainboard.



Step	Screw	Quantity	Screw Type
SIM Board	M1.6*1.5	2	

Replacing the Receiver Module

1. Insert the receiver module into the Lower Cover and ensure the clips snap into place.



Replacing the Vibration Module

1. Grasping the Vibration Module firmly from both sides, insert the Vibration Module into the vibration module well in the Lower Cover.



2. Press the vibration module into place until the edges are flush with the well.



Replacing the Mainboard

1. Insert the Mainboard into the Lower Cover as shown. The I/O port and green tab on the main board should be inserted fully into the main board, then drop the side with the SD card reader into place. make sure that all screw holes align.

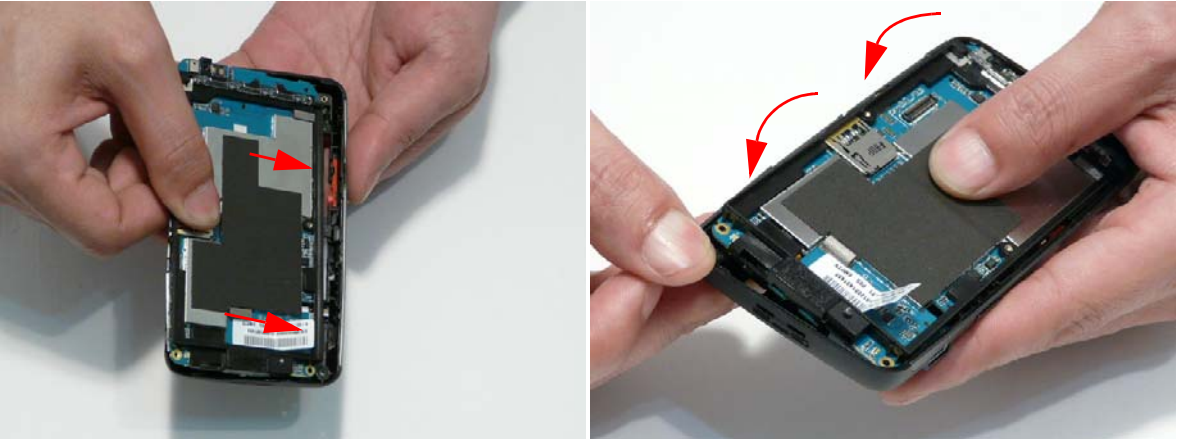

2. Insert the rubber protector for the Microphone as shown.

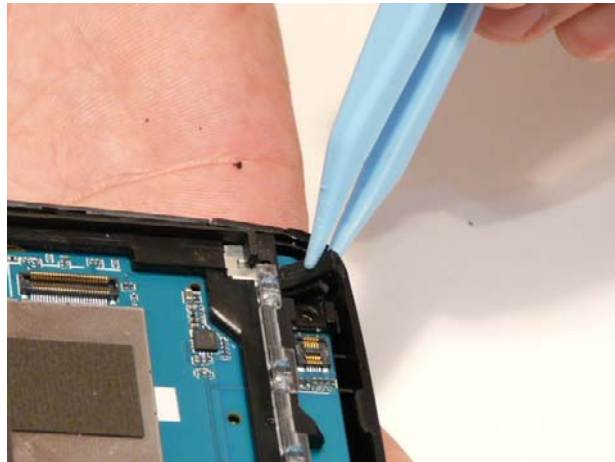

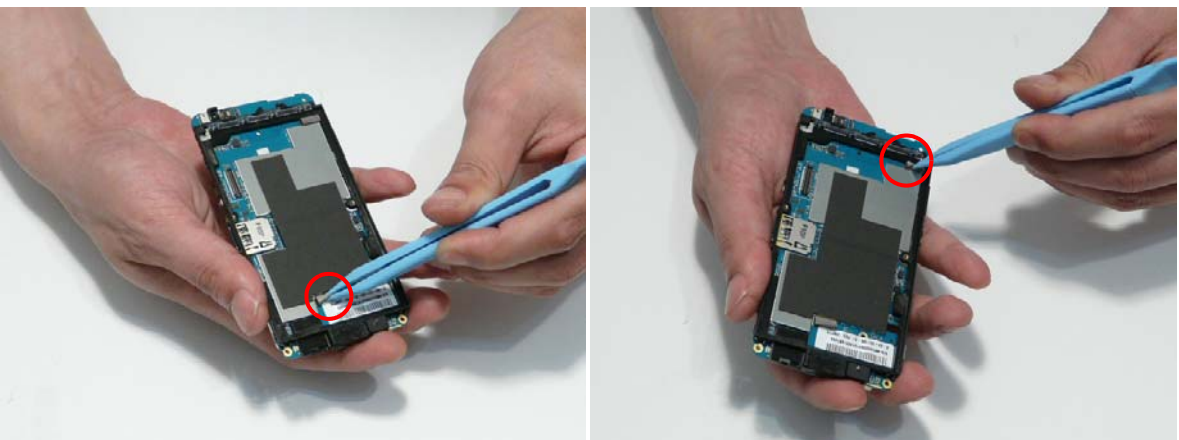

3. Replace the two spacer pads on the Mainboard as shown below

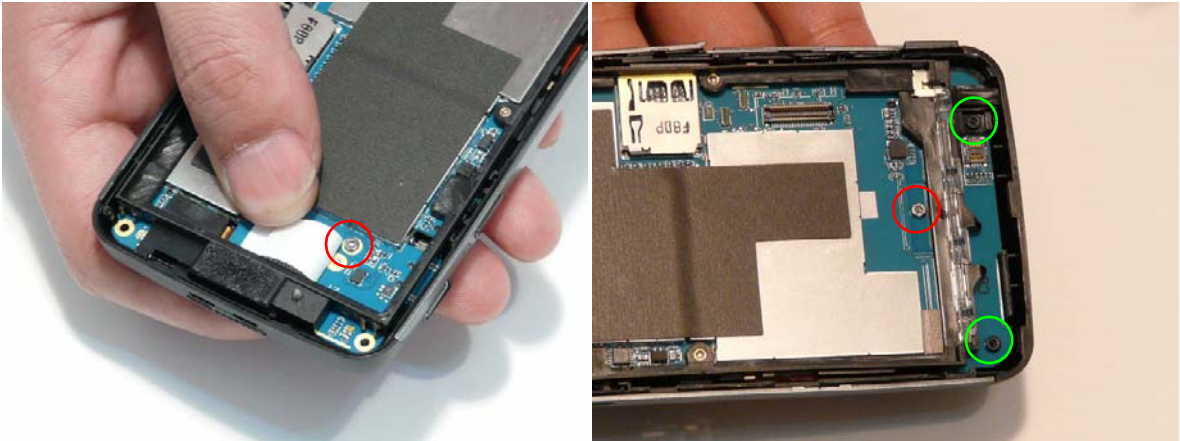

- Replace the four screws to secure the Mainboard to the Lower Cover.



Step	Screw	Quantity	Screw Type
Mainboard (red callout)	M1.6*3.5	2	
Mainboard (green callout)	M1.6*5	2	

- Turn the smartphone over. Insert the two screws to secure the Mainboard to the Lower Cover.



Step	Screw	Quantity	Screw Type
Mainboard	M1.6*2	2	

Replacing the LCD Module

1. Reapply the adhesive to the LCD FFC Cable as shown.



2. Reconnect the LCD FFC to the main board as shown.

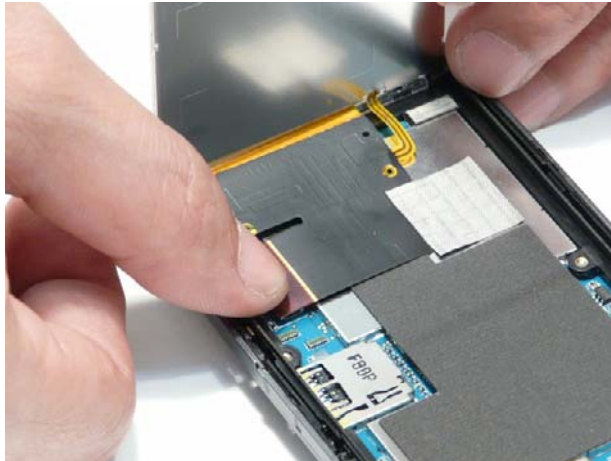

3. Reapply the adhesive LCD gasket.

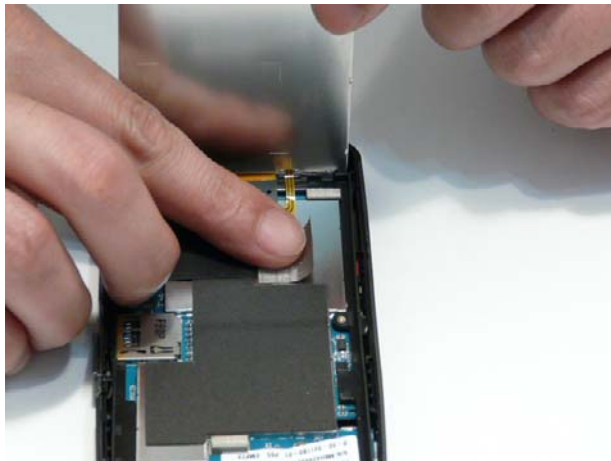

-
4. Insert the LCD Panel into the middle cover.



Replacing the Upper Cover

1. Connect the screen FFC to the Mainboard.



2. Align the cover tabs and slide the tabs into the slots in the lower cover assembly.



3. Press the bottom of the covers together, starting with one side and moving to the other.



4. Using a pinching motion, press the edges of the covers together, working from the base of the unit to the top. Attach one side at a time.



5. Pinch the top edge together.



6. Insert the two screws located on the sides of the Lower Cover.



Step	Screw	Quantity	Screw Type
Upper Cover	M1.6*1.5	2	

7. Insert the two screws into the back of the unit.



Step	Screw	Quantity	Screw Type
Upper Cover	M1.6*5	2	

8. Insert the two rubber screw caps into the Lower Cover.

Replacing Internal Module Components

Replacing the SIM Card

1. Slide the SIM Card into the SIM slot as shown.



Replacing the Battery

1. Insert the Battery into the battery bay.



2. Slide the Battery lock in the direction of the arrow to lock the Battery in place.



Replacing the Back Cover

1. Insert the bottom of the Back Cover into the smartphone.



2. Push the back cover into place.



Replacing the Mini-SD Card

1. Insert the card into the slot until it clicks into place.



-
2. Rotate the Mini SD door towards the card slot as shown.



3. Push the door into the case to secure it in place.



Replacing the Stylus

1. Push the stylus into the stylus holder in the base of the smartphone as shown.



Diagnostics and Troubleshooting

Using DebugSwitcher Function Testing

RUN IN and Discharge Tests

NOTE:

- Wear anti-static gloves.
1. Insert the battery, battery cover and charger in to the handset and power on.
 2. Tap **LED** and wait for the keypad LED to light. Tap **OK** to test.
 3. Tap **BurnIn Test** for Run in testing.
 4. When the screen shows **PASS** the handset has passed all tests,
 5. Check if the handset LED always lights green. If yes, handset passed.
 6. Check if the temperatures of the handset, battery and charger are OK and not too high. If the temperature is excessively high, the handset failed.
 7. If the handset, battery and charger is OK, take the charger off.
 8. Unplug the travel charger and go back to the **Debugswitcher** display. Click the **DCB** to discharge the battery.
 9. After discharge, check if the battery capacity is less than 55% and if the screen shows Pass. If so, the handset passed.
 10. Check if the handset and battery temperature is excessively high. If not, the handset passed.

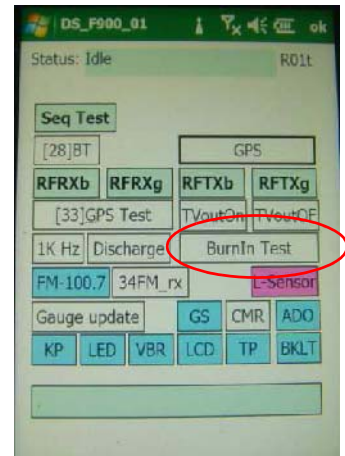

FM Receiver, Audio and GPS1 Tests

NOTE:

- Take care not to damage the casing when putting the handset on the test fixture.
1. Plug in the FM Receiver test cable into the handset USB port and press **FM Rx** test. If the test shows **Pass**, the handset passed.
 2. If the test is Pass, put the handset in the tray and click **GPS** for GPS testing. If the test shows **Pass**, the handset passed.
 3. Put the handset in the Audio Test fixture and click **1K Hz** to test Audio functions.
 4. Check if the value is less than the limited value. If so, the device passed.

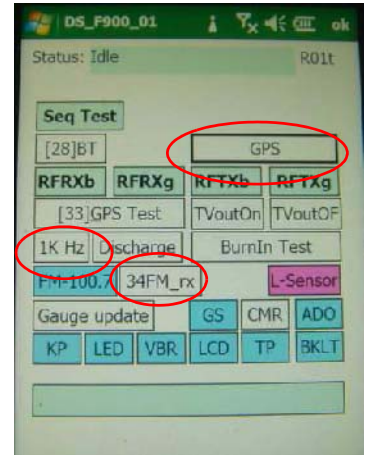

Camera Test

NOTE:

- Wear anti-static gloves.
 - Take care not to damage the casing when putting the device on the test fixture.
 - Make sure that the handset camera can auto-focus.
1. Tap **CMR** to begin testing.
 2. Hold the handset at 3m to test focus functionality. Check for color shifts, blurring, and distortion. If there is no issue, the handset passed.
 3. Repeat step 2 using a sheet of white paper with a single black dot in the centre to confirm the camera test. Press **Macro** and then test the front VGA camera for full functionality.
 4. Focus the handset on the ceiling light. If the display does not turn partially yellow, it passed.
 5. Press the Power and Reset buttons simultaneously, then press and hold the camera button. The camera enters night mode. Check to be sure that the camera displays properly while in a dark area.

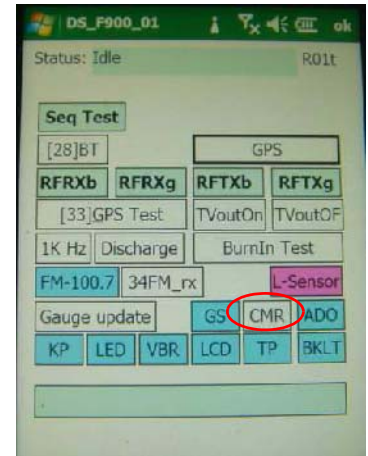

Function Testing 1

NOTE:

- Wear anti-static gloves.
1. Tap **Seq Test** to begin testing functions.
 2. The **LCD Test** starts. Tap the screen to cycle through white, black, red, green, and blue backgrounds.
 - Check that the white screen displays no black dots.
 - Check that the black screen displays no white dots.
 - Check that the RGB screens display with no color distortion or bleeding.
 3. Tap **OK** if the test is passed.
-
4. Tap the screen to test the **Backlight** function.
 5. Tap **ON** and **OFF** to test functionality.
 6. Tap **UP** and **DOWN** to test the brightness functionality.
 7. Tap **OK** if the test is passed.
-
8. Tap the screen to test the five integrated LEDs.
 9. Tap **ALL ON** and verify that the Blue, White, Orange, Red, and Green LEDs light.
 10. Tap **ALL OFF** to complete the test.
 11. Tap **OK** if the test is passed.

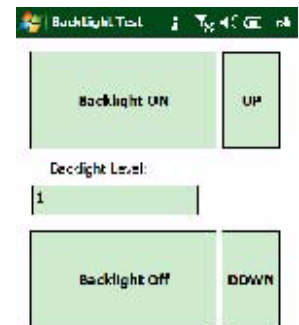
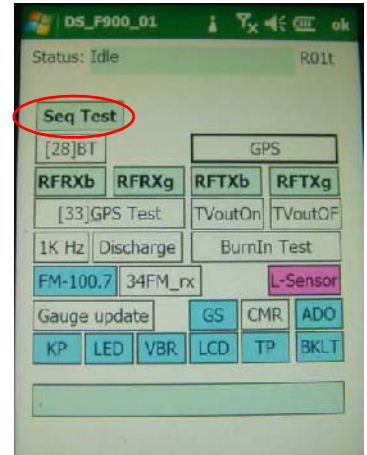

12. Tap the screen to test the **Vibration** function.

13. Tap **ON** and **OFF** to test the functionality.

Ensure that the vibration is not too strong or too weak, and noise-less.

14. Tap **OK** if the test is passed.

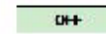
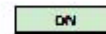

Function Testing 2

NOTE:

- Wear anti-static gloves.
 - When testing the touch panel pen, draw from corner to corner and side to side. Do not start in the centre of the screen.
1. Tap the screen to test the various key/button functions.
 2. Tap the keys shown in the image to test the functionality. Ensure that the keys are not loose or unresponsive.
 3. Tap **OK** if the test is passed.

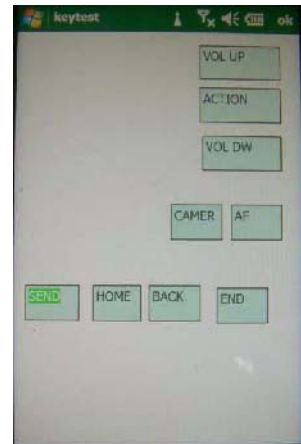

4. Tap the screen to perform the PenTrac test.
5. Draw a star as shown to test the full extent of the touchpad.
6. Tap **X** (in the top right corner of the screen) if the test is passed.

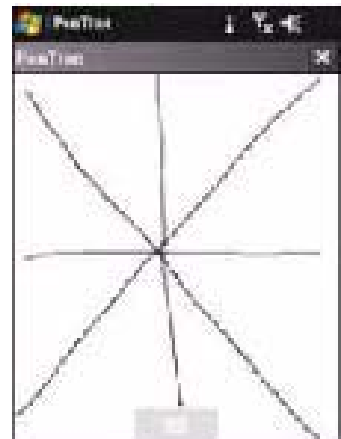

7. Tap the screen to perform Audio Tests.
8. Tap **SPK** to start recording. Ensure the voice is normal from speaker.
9. Tap **Receiver Test** to check the receiver functionality.
10. Plug in a headset and ensure that the headset icon turns red.
11. Press answer button on the phone keypad and check the screen displays the answer key icon.
12. Tap **HP Recording** to start recording, and ensure the voice is normal from speaker.
13. Tap **OK** to go to the **FM test** item. Make sure that music is heard from the headset, then remove the headset.
14. Tap **OK** if the tests are passed.



G Sensor and Light Sensor Tests

NOTE:

- Wear anti-static gloves.
 - Take care not to damage the casing when putting the device on the test fixture.
 - Ensure the Light Sensor Test Fixture timer is reset to 0 (zero) before use.
 - Please use the Golden Sample to calibrate tests before use.
1. Press **OK** to start the **G Sensor Test**.
 2. Tap **Start** to begin the test.
 3. The screen shows Z, -Z, X, -X, Y, and -Y on the screen. After each position, move the handset according to the specified directions as follows:
 - **Z**: Handset screen faces up
 - **-Z**: Turn handset so that battery cover faces up
 - **X**: Rotate handset clockwise 90 degrees.
 - **-X**: Rotate handset anti-clockwise 90 degrees.
 - **Y**: Rotate handset clockwise 180 degrees.
 - **-Y**: Keep handset in normal position, facing up.
 4. After each position shift, the handset beeps to indicate that you should change the position. A set of 6 beeps indicates that the device passed the test.
 5. Tap **Light Sensor Test** to enter the Light Sensor test page.
 6. Tap **Start** to begin the test.
 7. If the screen shows **PASS**, the device has passed the test.

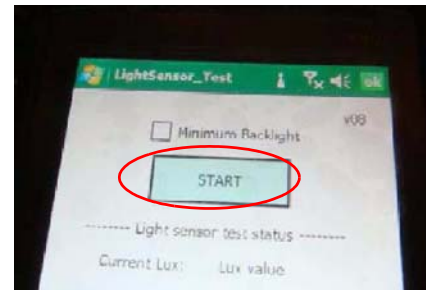

TV-out and GPS2 Test

NOTE:

- Wear anti-static gloves.
1. Assemble the battery then power on.
 2. Press the **TV Out** tab to test TV-Out function.
 3. Make sure that the speaker generates Left, Right, and Centre channel output. Check if the monitor displays TV-output handset signal. If so, the device passed the test.
 4. Scan bar code of the device with a barcode reader.
 5. Plug in a USB cable to the handset then put in the test fixture for testing.
 6. If the screen turns green, the handset passed the GPS2 test.



Using the Windows Mobile Test System

Testing Item	Procedure	Guidelines
Phone Live Test	Test phone dial and receive function: <ol style="list-style-type: none"> 1. Device over device to testing 2. Use wired Headset to answer call 3. Use Bluetooth headset to answer call 	Check Dial/Answer the phone call's voice is clear enough
USB connection	Synchronize PDA with PC	Connected USB to check PDA can be communicate with PC's ActiveSync
Camera with Micro SD card Read/Write Test	<ul style="list-style-type: none"> • Snap shot a photo then delete it • Save the file in Micro SD card 	<ol style="list-style-type: none"> 1. Check Camera function and photo appear normal 2. Check read, write & delete the storage file by Micro SD card
WiFi Test	<ol style="list-style-type: none"> 1. Enable Wireless 2. Execute Internet Explore to check if the Wireless LAN works well 	Must be able to open a website
	NOTE: For problems related to Firewall and using Proxy, please contact your IT specialists	
GPS Test	<ol style="list-style-type: none"> 1. Execute the application as GPS Viewer 2. Check the contents of application 	Satellite searching status <ol style="list-style-type: none"> 1. No time limitation 2. Fix: 3D Fixed
Power Consumption Test	Tools: <ul style="list-style-type: none"> • Dummy battery • Power consumption program (2577) • Power supply • Micro SD card <ol style="list-style-type: none"> 1. Turn off power button, check SI 2. Check the contents of application 3. Insert SD card (containing program 2577) in to device 4. Execute the program under OS 5. Select Backlight ON/OFF to test TI 6. Select Clean Boot to reboot. Once Windows welcome appears, turn off power and remove dummy battery 	Notes: SI: Current ≤ 12 mA TI: Backlight ON current ≤ 180 mA (GSM/BT/WLAN/GPS ALL OFF) TI: Backlight OFF current ≤ 100 mA (GSM/BT/WLAN/GPS ALL OFF)

Serial Number Definition

The following information describes the serial number details available on the Acer product sticker. To view the serial number, remove the Back Cover and Battery (see “Disassembly Process” on page 1) as shown below:



The following describes the information on the product sticker:

Acer 22 Barcode

Follows Code 128 standard—refer to <http://www.adams1.com/pub/russadam/128code.html>

Acer_22_Code_SN

PPPPPPPPPYWWSSSSMMVV

Code	Description
PPPPPPPPPP	Acer Part Number
YWW	3 digit numeric year and week code
SSSSS	5 character unique hexadecimal code by manufacturer base and reset each week (0-9, A, B, C, D, E, F 16 code)
MM	Manufacturer code
VV	English version code

Acer SNID

YWWddddMM

Code	Description
YWW	3 digit numeric year and week code (as above)
dddddd	6 digit unique number derived from Acer 22 Code SN (SSSSS) Transfer Rule: $S_1S_2S_3S_4S_5$ $dddddd = S_1 * 16^4 + S_2 * 16^3 + S_3 * 16^2 + S_4 * 16 + S_5$ For example: 001FD = 000509 ($1 * 16^2 + 15 * 16 + 13$)
MM	Manufacturer code (as above)

FRU (Field Replaceable Unit) List

This chapter gives you the FRU (Field Replaceable Unit) listing in global configurations of the F900 smartphone. Refer to this chapter whenever ordering for parts to repair or for RMA (Return Merchandise Authorization).

Please note that WHEN ORDERING FRU PARTS, you should check the most up-to-date information available on your regional web or channel. If for whatever reasons a part number change is made, it will not be noted on the printed Service Guide. For ACER AUTHORIZED SERVICE PROVIDERS, your Acer office may have a DIFFERENT part number code from those given in the FRU list of this printed Service Guide. You MUST use the local FRU list provided by your regional Acer office to order FRU parts for repair and service of customer machines.

NOTE: To scrap or to return the defective parts, you should follow the local government ordinance or regulations on how to dispose it properly, or follow the rules set by your regional Acer office on how to return it.



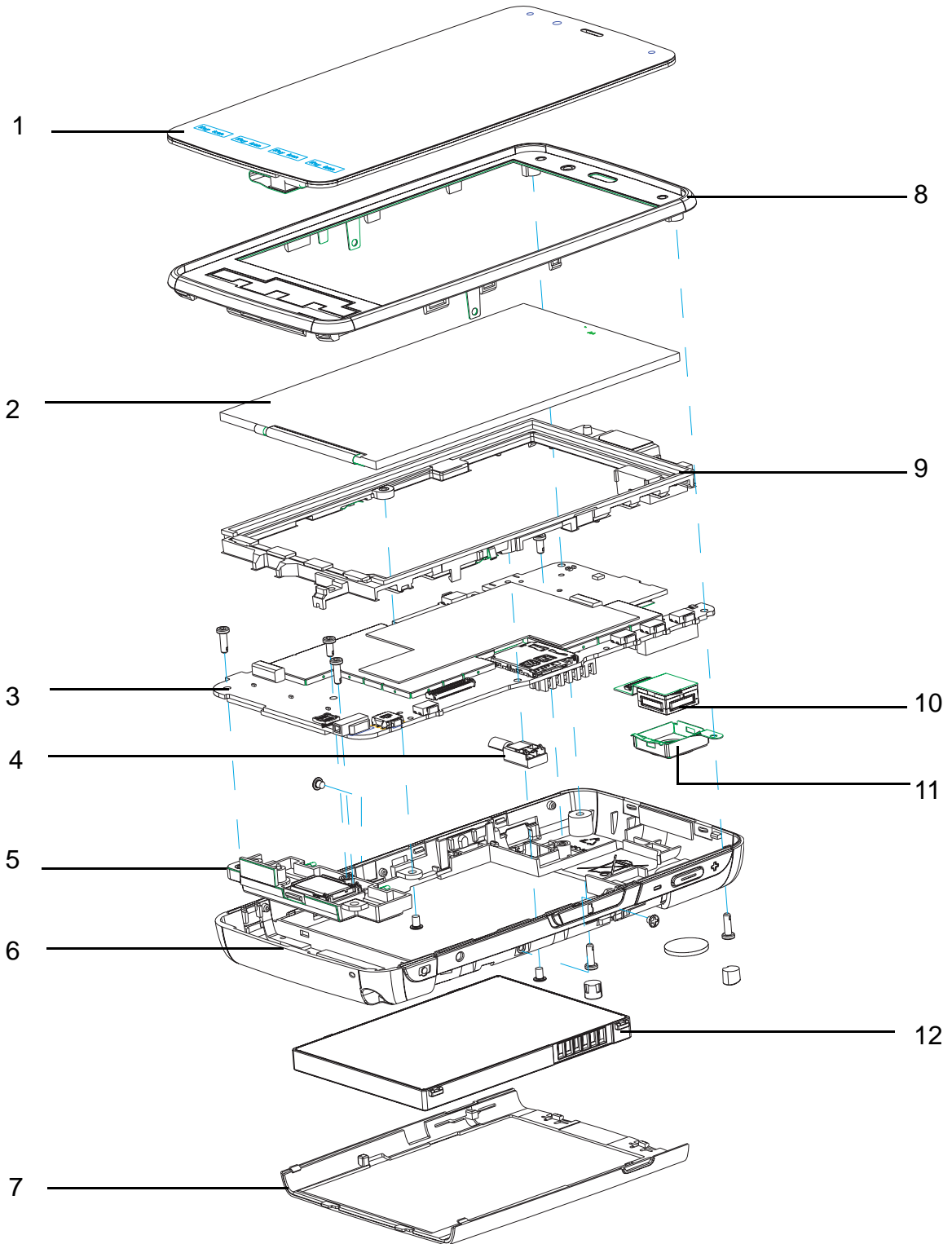

F900 Smartphone Exploded Diagram





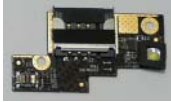

Item	Description	Part Number
1	Touchscreen	60.H420S.004

Item	Description	Part Number
2	LCD Module	6M.H420S.001
3	Mainboard	MB.H4200.001
4	Vibration Module	60.H420S.001
5	Receiver	60.H420S.002
6	Back Cover	60.H420S.005
7	Battery Cover	60.H420S.010
8	Front Cover	60.H420S.004
9	Middle Cover	60.H420S.007
10	Camera	QM.03M02.001
11	Camera Shield	60.H420S.008
12	Battery	BT.0010T.003

F900 Smartphone FRU List

		Acer P/N
ACCESSORY		
	USB CABLE	6K.H370S.001
	STYLUS.F900	6K.H420S.001
	STYLUS WITH BAG PACKING.F900	6K.H420S.002
	LEATHER POUCH.F900	6K.H420S.003
	PU POUCH.F900	6K.H430S.003
	ADAPTER	AP.0050P.001
	AC ADAPTER EU-PLUG	AP.0050P.002
	AC ADAPTER UK-PLUG	AP.0050P.003
	AC ADAPTER US-PLUG	AP.0050P.004
	AC ADAPTER AU-PLUG	AP.0050P.005
	HEADSET.F900	QH.00205.003
	BATTERY.F900	BT.0010T.003
	DUMMY BATTERY.F900	6K.H420S.004
BOARD		
	M/B F900	MB.H4200.001
	SIM BOARD.F900	
MISCELLANEOUS		
	GASKET_3311_GRAY_CONDUCTIVE GASKET _N/A_GASKET FOR MAIN PCB_U- TEK_33002700	47.H420S.001
CABLE		
	FPC	50.H420S.001
CASE/COVER/BRACKET ASSEMBLY		
	VIBRATOR.F900	60.H420S.001

		Acer P/N
	RECEIVER.F900	60.H420S.002
	SPEAKER.F900	60.H420S.003
	FRONT COVER ASSY.F900	60.H420S.004
	REAR COVER ASSY.F900	60.H420S.005
	ANTENNA (GSM/DCS/PCS/WCDMA)+FPC TYPE	60.H420S.006
	LCM FRAME	60.H420S.007
	SHIELD COVER FOR 3M CAMERA	60.H420S.008
	HOLDER_3311_BLACK_RUBBER?SILICON RUBBER_N/A_MICPHONE CAP_PMP_43001420	60.H420S.009
LCD		
	LCM+FPC.F900	6M.H420S.001
MISCELLANEOUS		
	MYLAR FOR CAMERA B TO B CONN	47.H420S.002
	GASKET FOR EMP COVER	47.H420S.003
	REGULATION LABEL_ F900 (FOR TW & HK ONLY)	47.H420S.004
	REGULATION LABEL_WWE. F900 (FOR GLOBE)	47.H420S.005
	WARRANTY STICKER	47.H420S.006
	WATERING DETECTION LABEL.X960 / M900/ F900	XZ.70200.052

		Acer P/N
OPTICAL DEVICE		
	CAMERA.F900	QM.03M02.001
Screws		
	MACHINE SCREW_FLAT_CROSS(JCIS)_1.6MM M_1.5MM_BLACK_STEEL_PLATING ZINC_HNS _NYLOK.44001480	86.H420S.001
	MACHINE SCREW_FLAT_TORX_1.6MM_5MM_ BLACK_STEEL_PLATING ZINC_HNS_T5.NYLO K.44001510	86.H420S.002
	MACHINE SCREW_FLAT_CROSS(JCIS)_1.6MM M_2MM_BLACK_STEEL_PLATING NICKEL_HN S_NYLOK.44001490	86.H420S.003
	MACHINE SCREW_FLAT_TORX_1.6MM_3.5MM _SILVER_STEEL_PLATING NICKEL_HNS_NYL OK	86.H420S.004

Online Support Information

This section describes online technical support services available to help you repair your Acer device.

If you are a distributor, dealer, ASP or TPM, please refer your technical queries to your local Acer branch office. Acer Branch Offices and Regional Business Units may access our website. However some information sources will require a user i.d. and password. These can be obtained directly from Acer CSD Taiwan.

Acer's Website offers you convenient and valuable support resources whenever you need them.

In the Technical Information section you can download information on all of Acer's products including:

- Service guides for all models
- User's manuals
- Training materials
- Software utilities
- Spare parts lists
- TABs (Technical Announcement Bulletin)

For these purposes, we have included an Acrobat File to facilitate the problem-free downloading of our technical material.

Also contained on this website are:

- Detailed information on Acer's International Traveler's Warranty (ITW)
- Returned material authorization procedures
- An overview of all the support services we offer, accompanied by a list of telephone, fax and email contacts for all your technical queries

We are always looking for ways to optimize and improve our services, so if you have any suggestions or comments, please do not hesitate to communicate these to us.

B

Back Cover
 Removing 6
 Replacing 41

Battery
 Removing 7
 Replacing 41

C

Camera Module
 Removing 26
 Replacing 31

Camera Shielding
 Removing 25
 Replacing 32

D

Display 4

E

External Module Disassembly
 Flowchart 2

F

Features 1
FRU (Field Replaceable Unit) List 1

L

LCD Module
 Removing 16
 Replacing 37

M

Main Unit Disassembly
 Flowchart 9

Mainboard
 Removing 18
 Replacing 35

Middle Cover
 Removing 27
 Replacing 28

Mini-SD Card
 Removing 4
 Replacing 42

R

Receiver Module
 Removing 22
 Replacing 34

S

SIM Board
 Removing 23
 Replacing 32

SIM Card
 Removing 8
 Replacing 40

Stylus
 Removing 3
 Replacing 43

System
 Block Diagram 4

U

Upper Cover
 Removing 11
 Replacing 38

V

Vibration Module
 Removing 21
 Replacing 34

Views 5

